

cebekit



KIT SOLAR 6 EN 1

C-0117



Aquest és un excel·lent equip educatiu per iniciar-se en el coneixement de l'energia solar fotovoltaica i també per ensenyar com actua el motor i fa moure cada un dels sis diferents models.









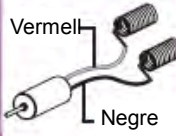

El kit proporciona un conjunt complet de peces de plàstic, panell solar i altres components necessaris. L'usuari pot utilitzar fàcilment les peces per construir 6 diferents models.

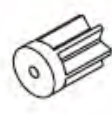
Alicates de tall



EINES NECESSÀRIES

COMPONENTS MECÀNICS

P1 Motor amb cable i molls  Vermell Negre 1	P2 Panell solar amb moll  1	P3 Piño (Groc)  1	P4 Eix  1
P5 Engranatge amb eix  1	P6 Esponja autoadhesiva  2	P7 Cable blanc 9 cm.  1	P8 Cable verd 9 cm.  1
P9 Cable blanc 23 cm.  1	P10 Cable verd 23 cm.  1		

PECES DE PLÀSTIC

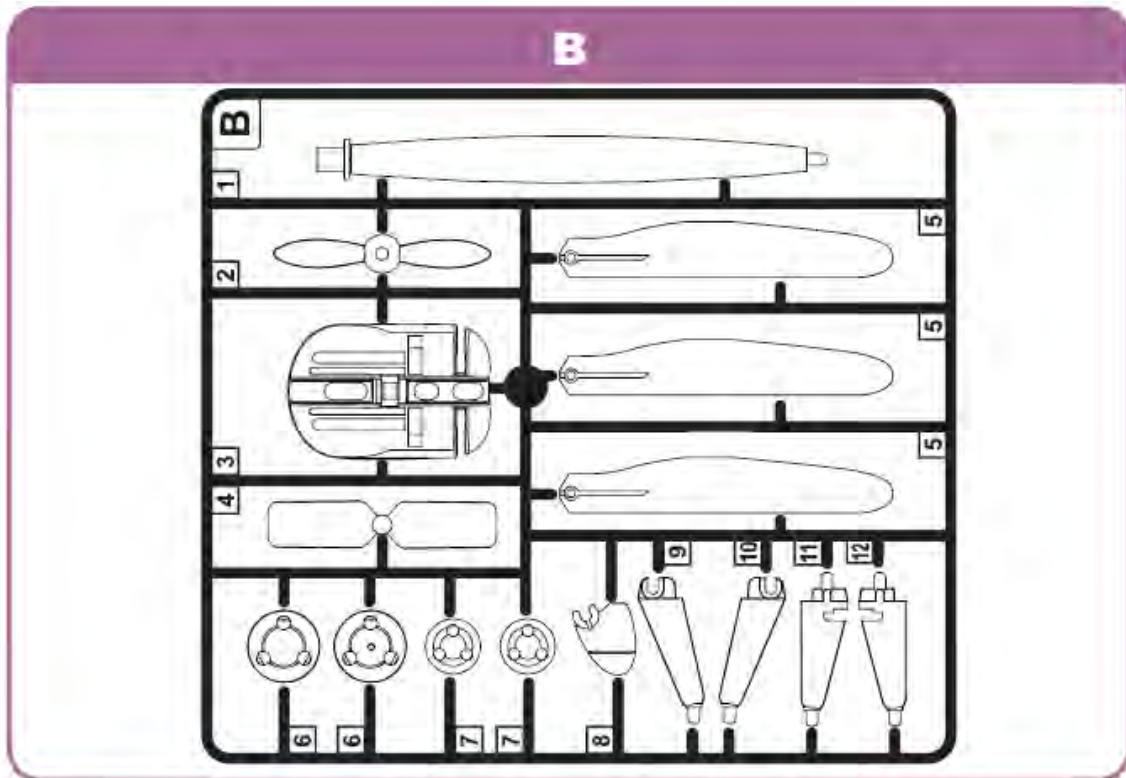
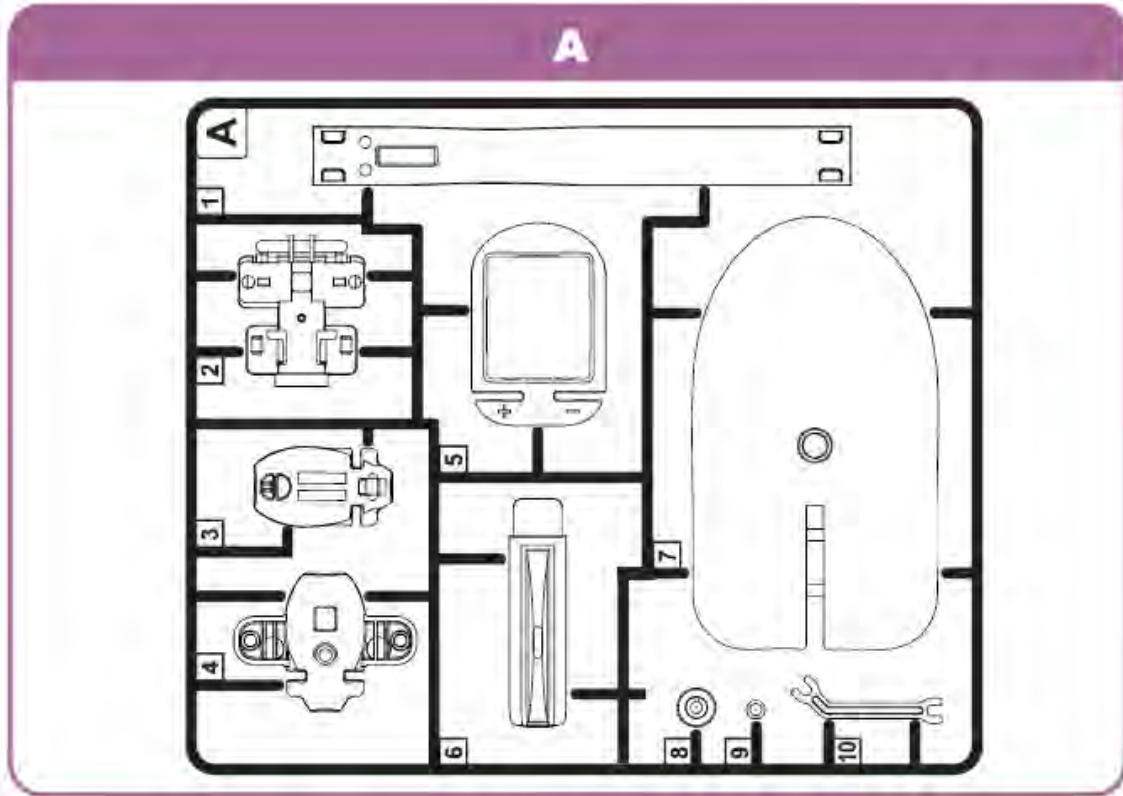

MUNTATGE DEL MOTOR REDUCTOR:

Peces necessàries

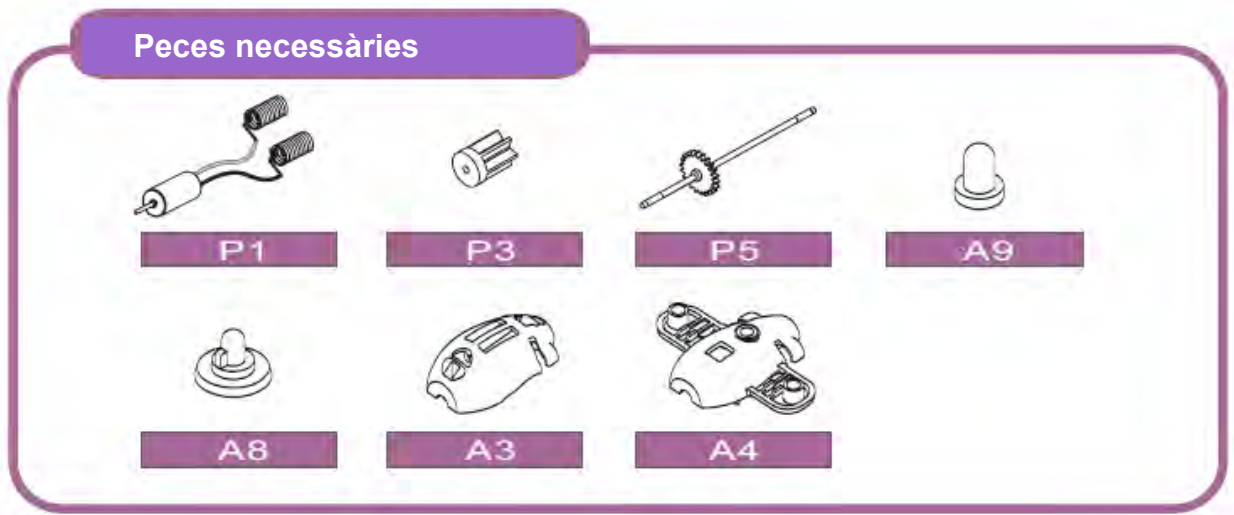

- P1
- P3
- P5
- A9
- A8
- A3
- A4

PAS 1

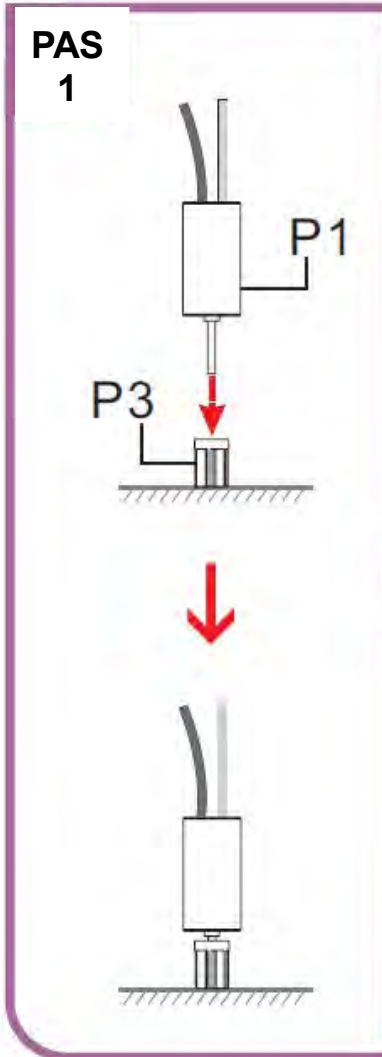

PAS 2

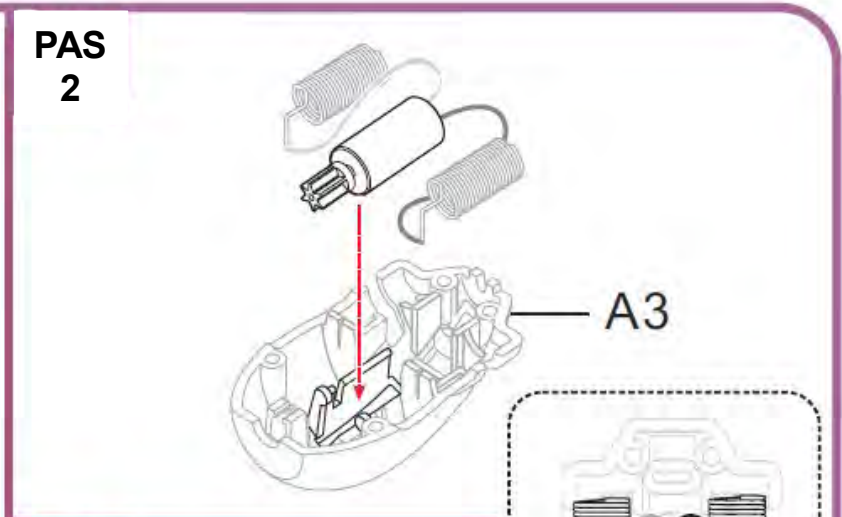

PAS 3

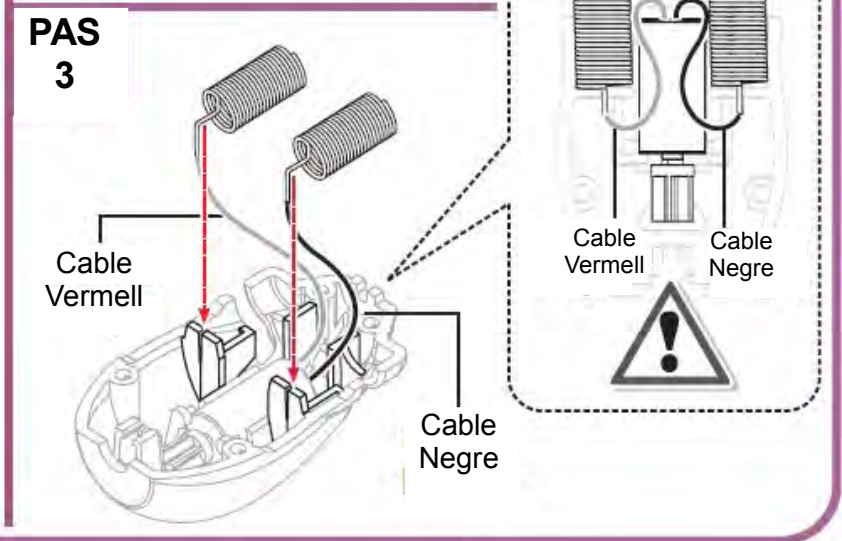

**PAS
4**

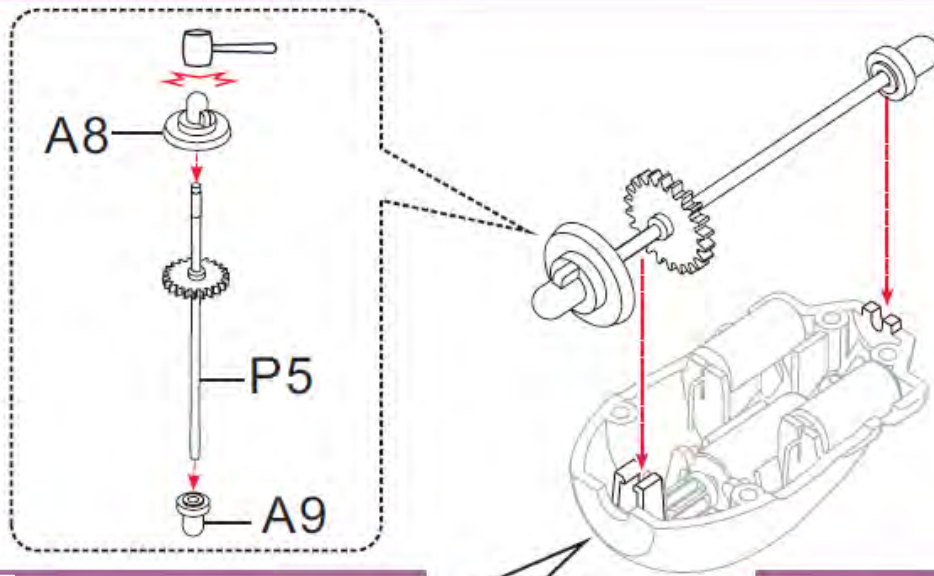

**PAS
5**

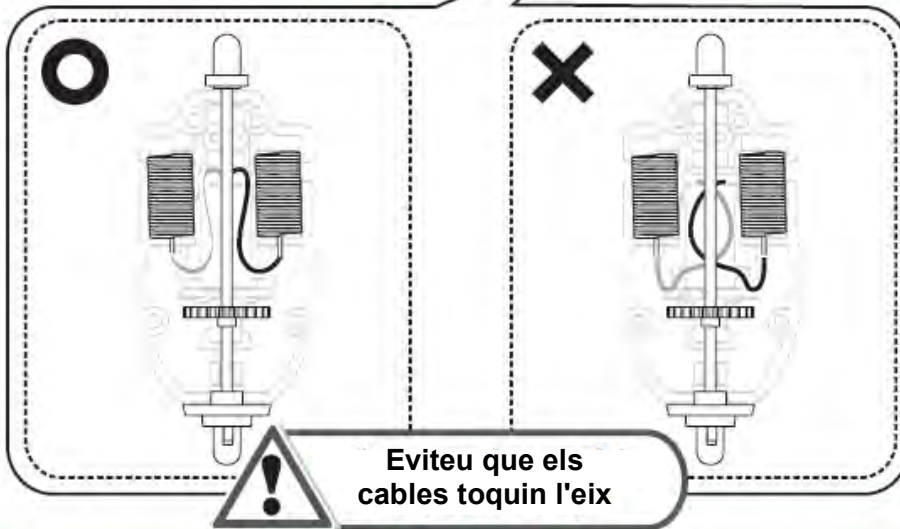

**PAS
6**

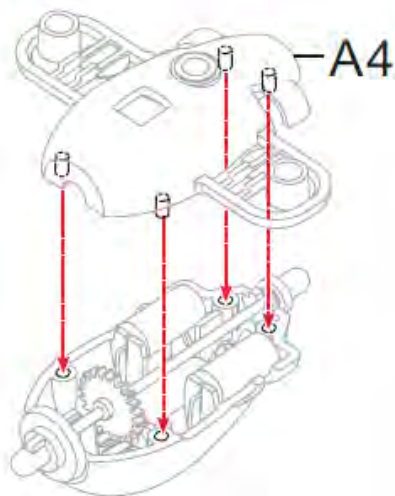

**PAS
7**

Muntatge finalitzat

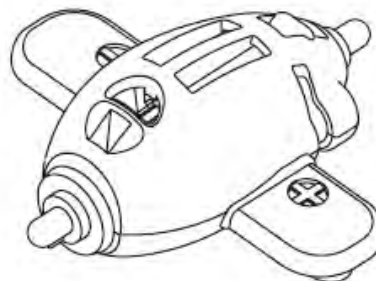

MUNTATGE DEL MÒDUL SOLAR:

Peces necessàries



P2



P6 x 2



A5

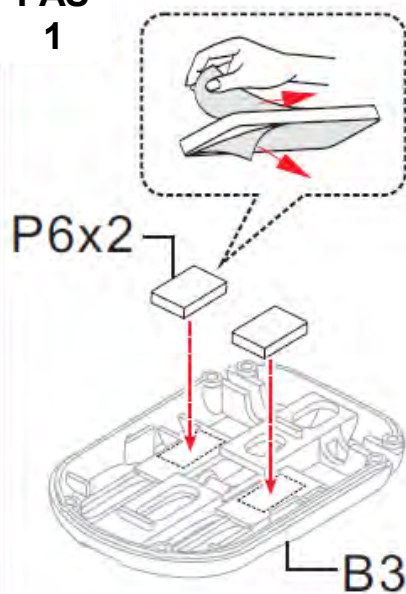
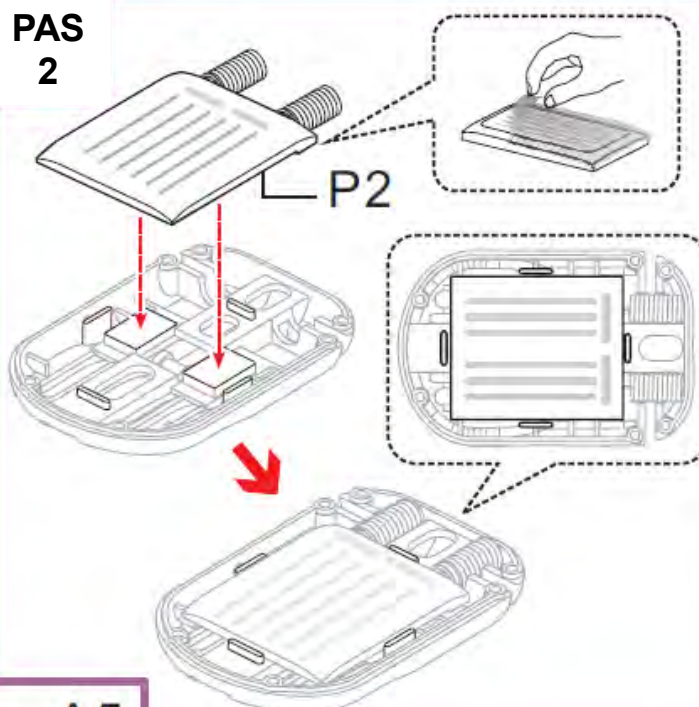
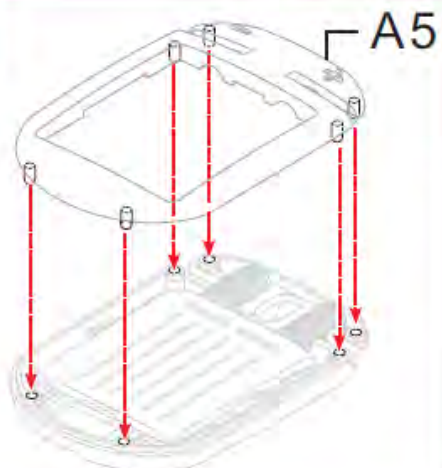

B3

PAS
1PAS
2PAS
3PAS
4

Muntatge finalitzat



COM FUNCIONA EL MOTOR REDUCTOR:

Peces necessàries



Mòdul solar

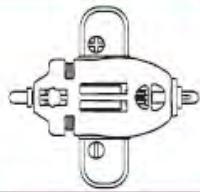

Motor reductor



P9



P10

PAS 1 **S'enrotlli els extrems dels cable**

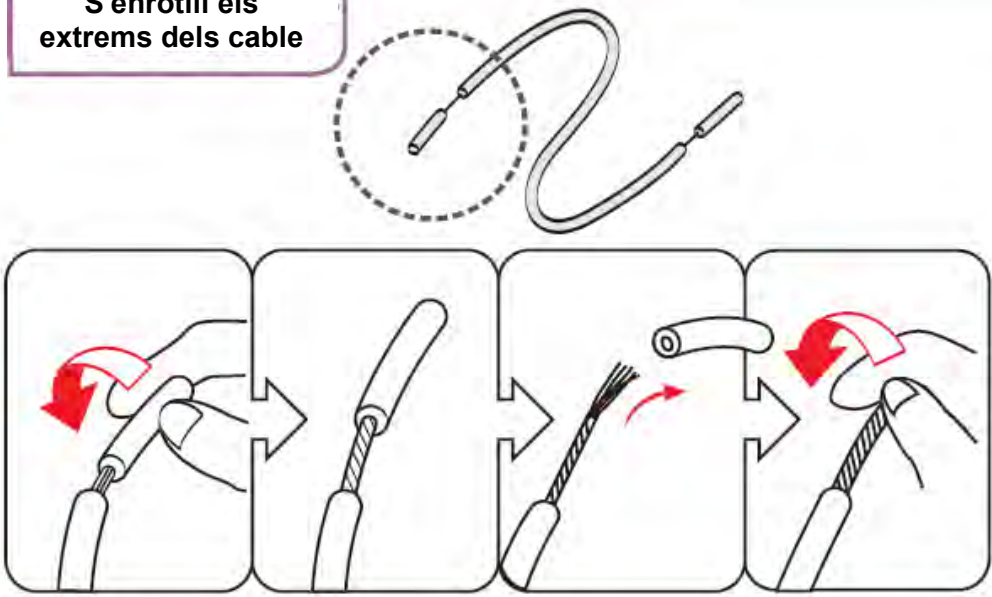

PAS 2

P9

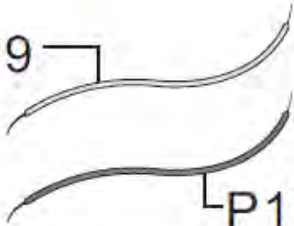

P10

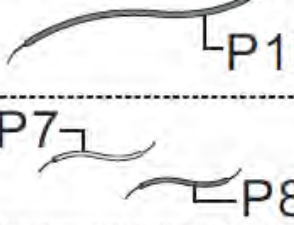

P7



P8





○



×



×

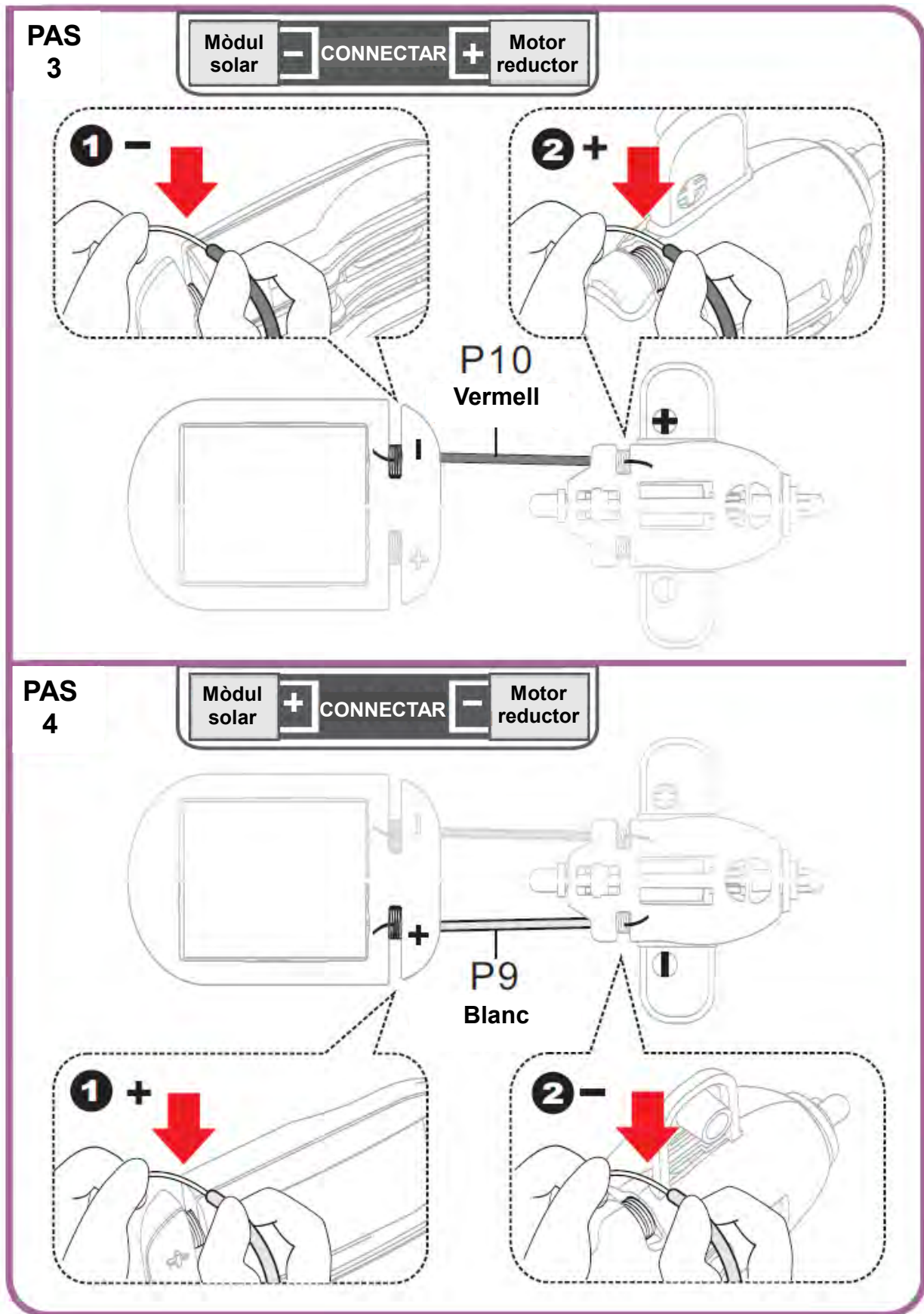

PAS 5

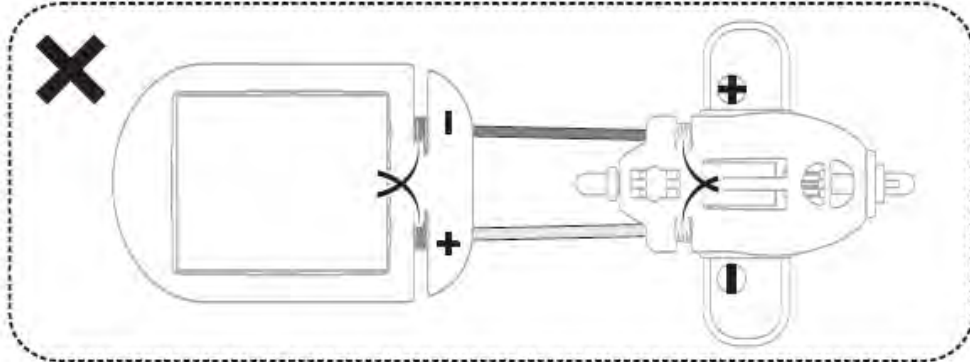
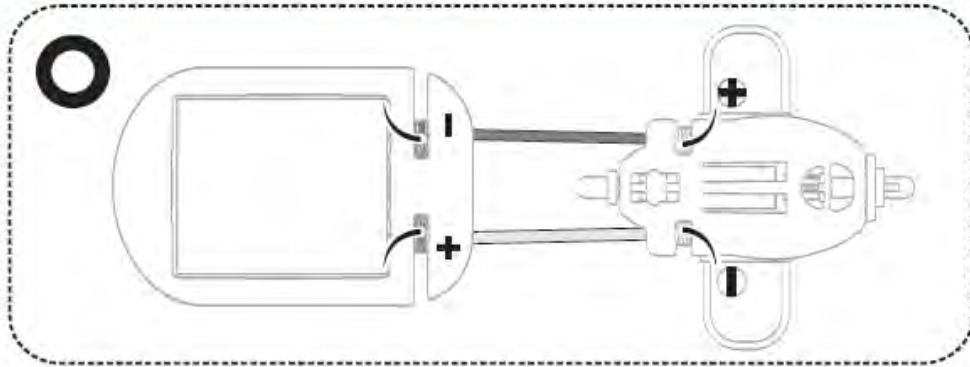

Eviteu que els cables toquin l'eix

PAS 6

Muntatge finalitzat

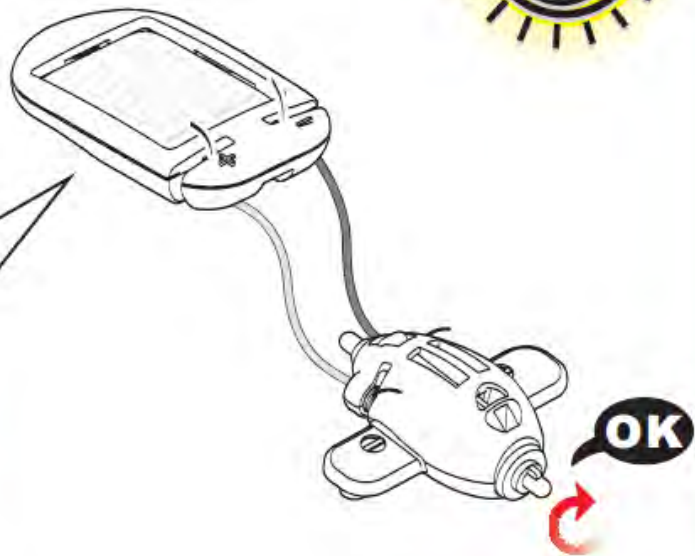

AEROGENERADOR SOLAR

Peces necessàries

Mòdul solar Motor reductor

B6 B5x3 A10 P10 P9 B1 A7

PAS 1

B6

B5x3

PAS 2

Caixa d'engranatges

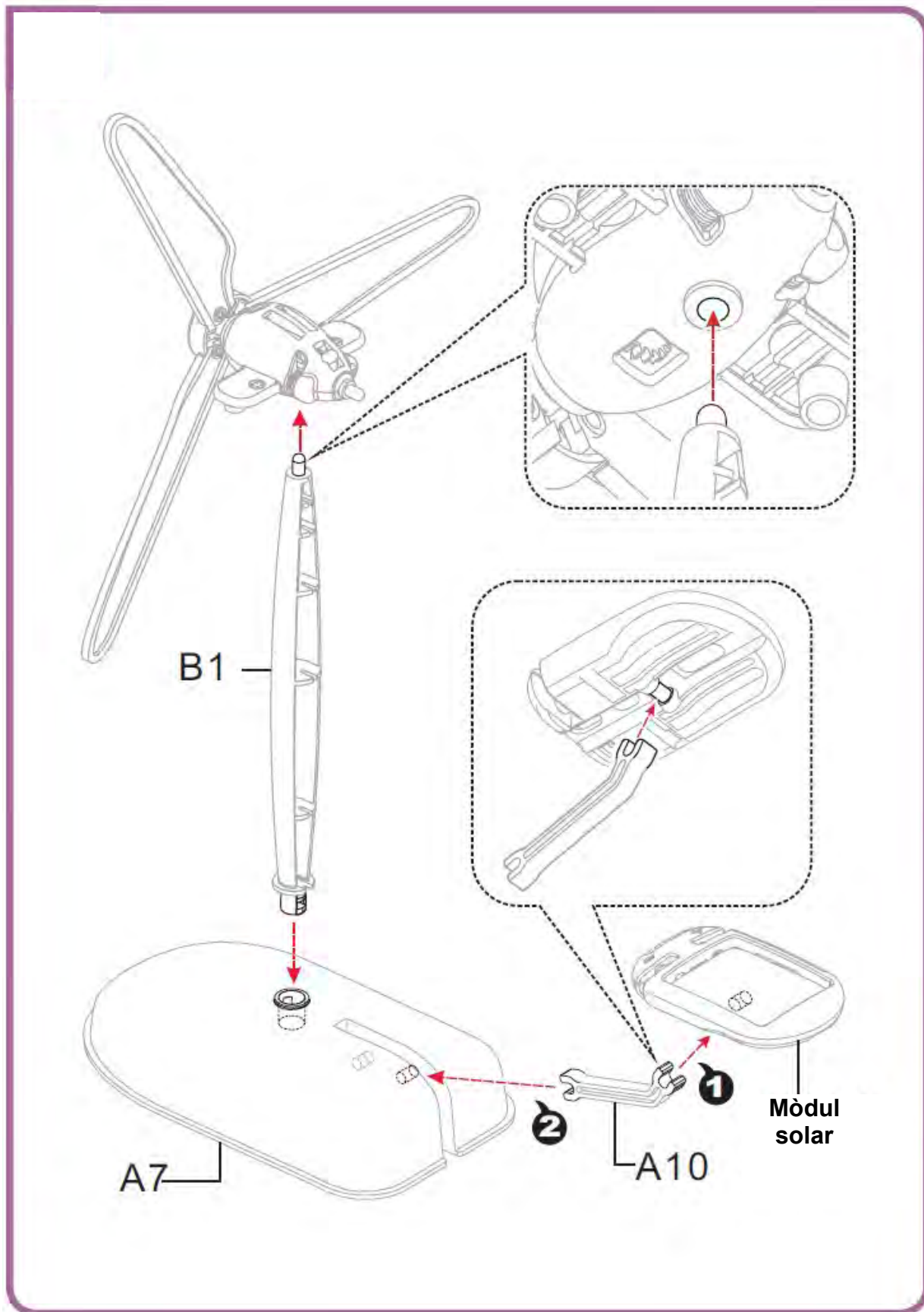

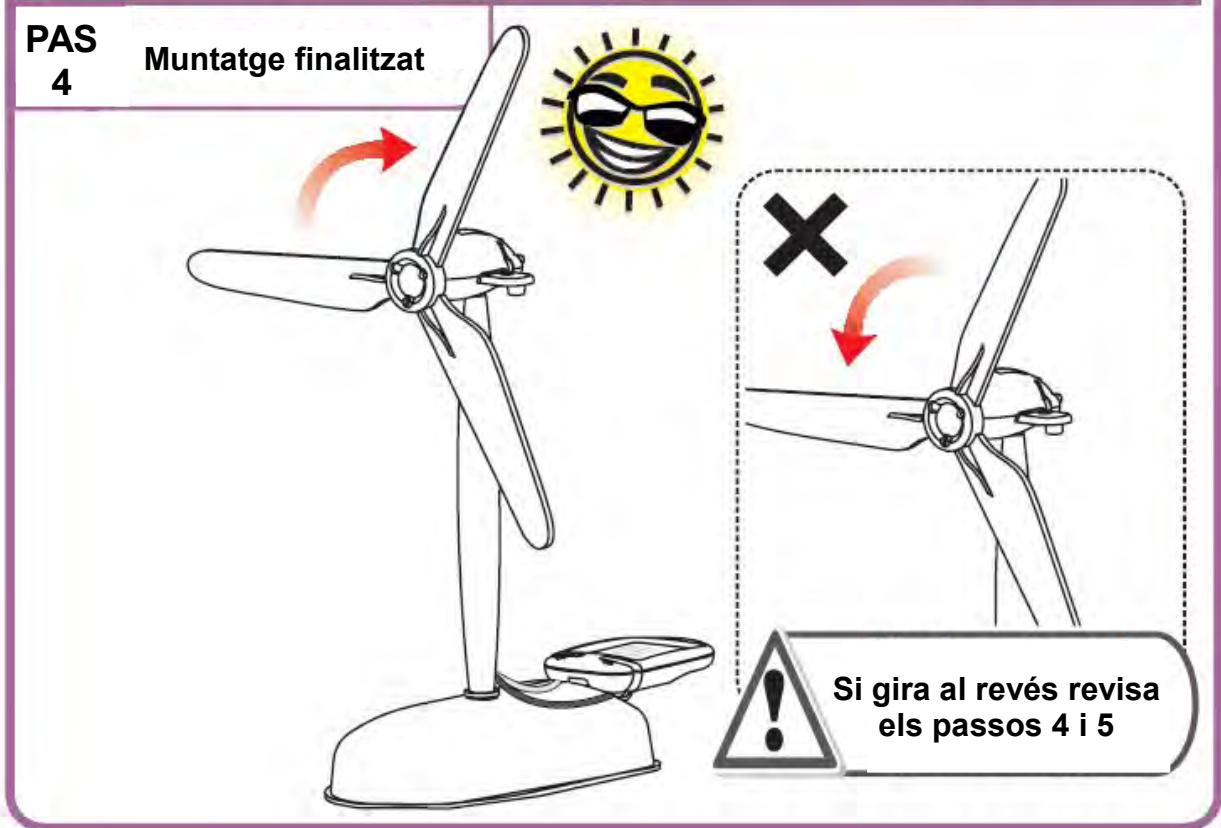
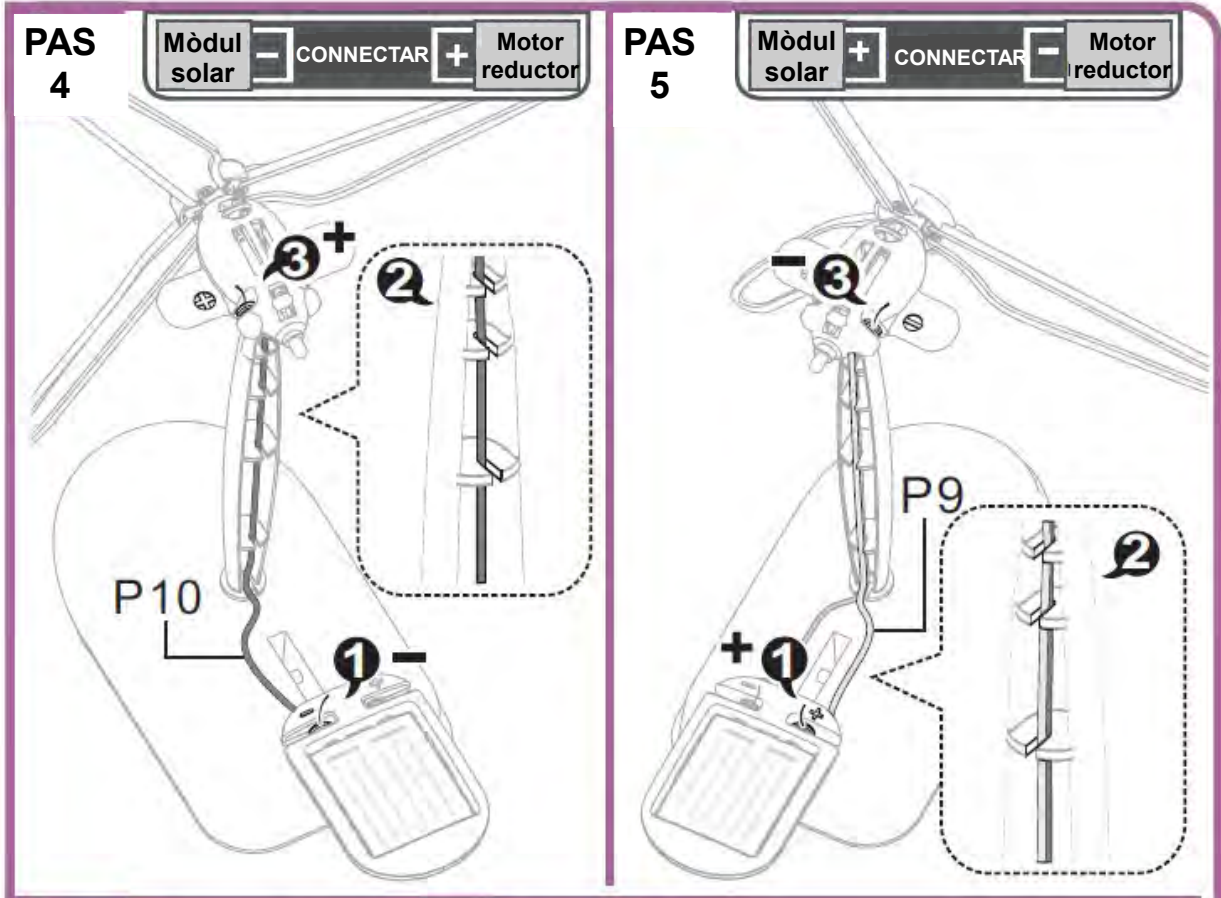





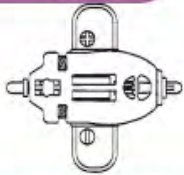

Aerolliscador SOLAR

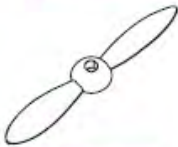
Peces necessàries

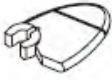

 Mòdul solar	 Motor reductor	 P7
 B2	 B9	 P8
 B8	 A10	 A7

PAS 1

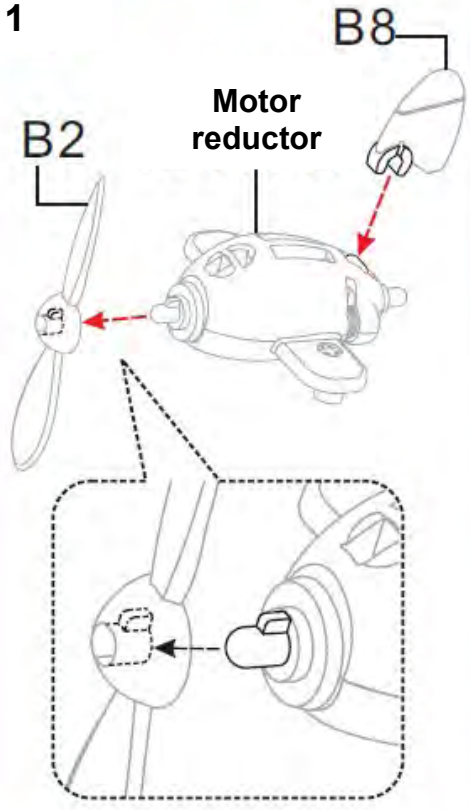

PAS 2

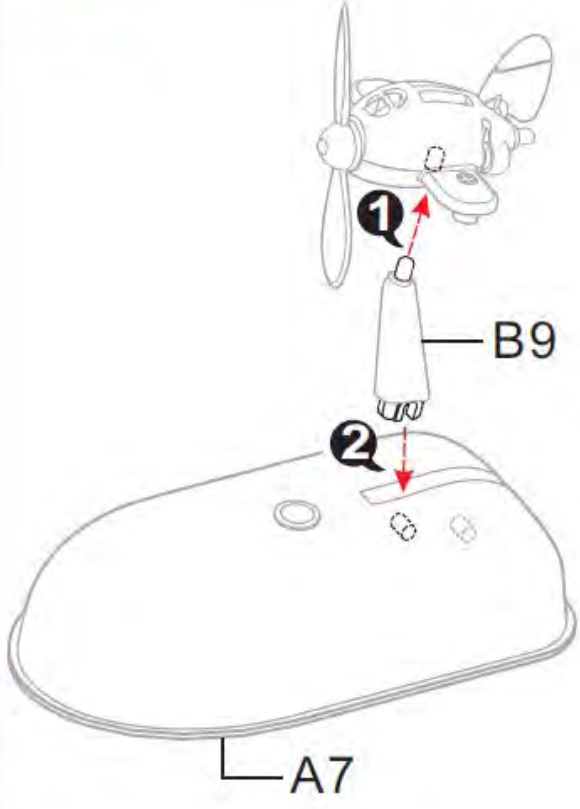

PAS 3

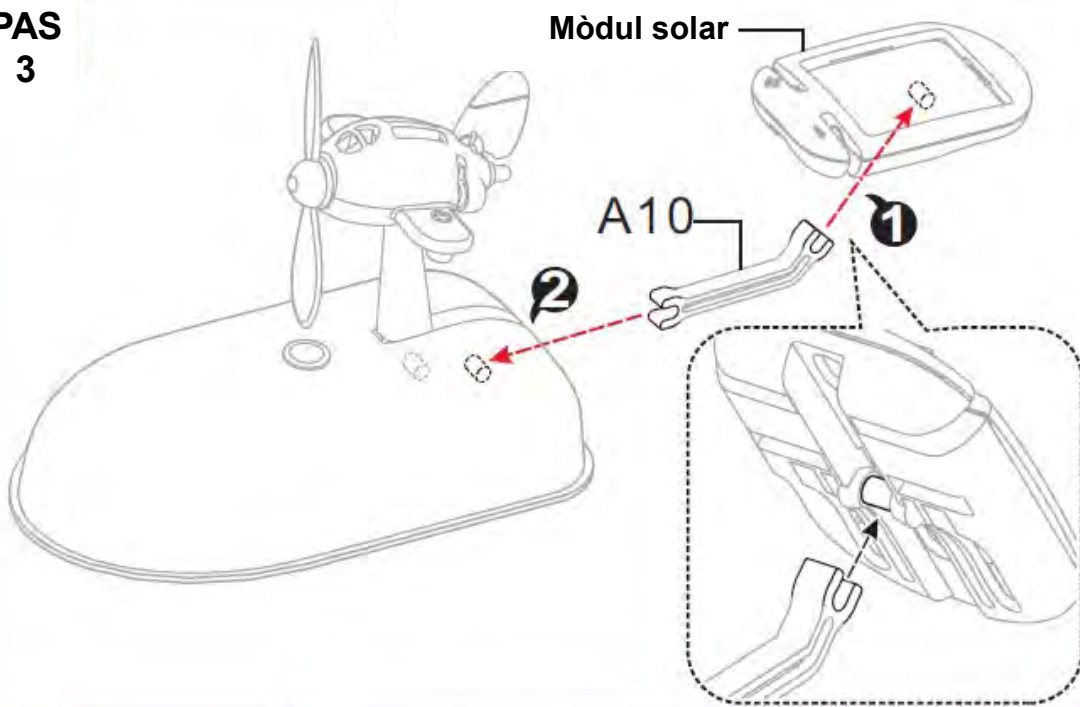

PAS 4

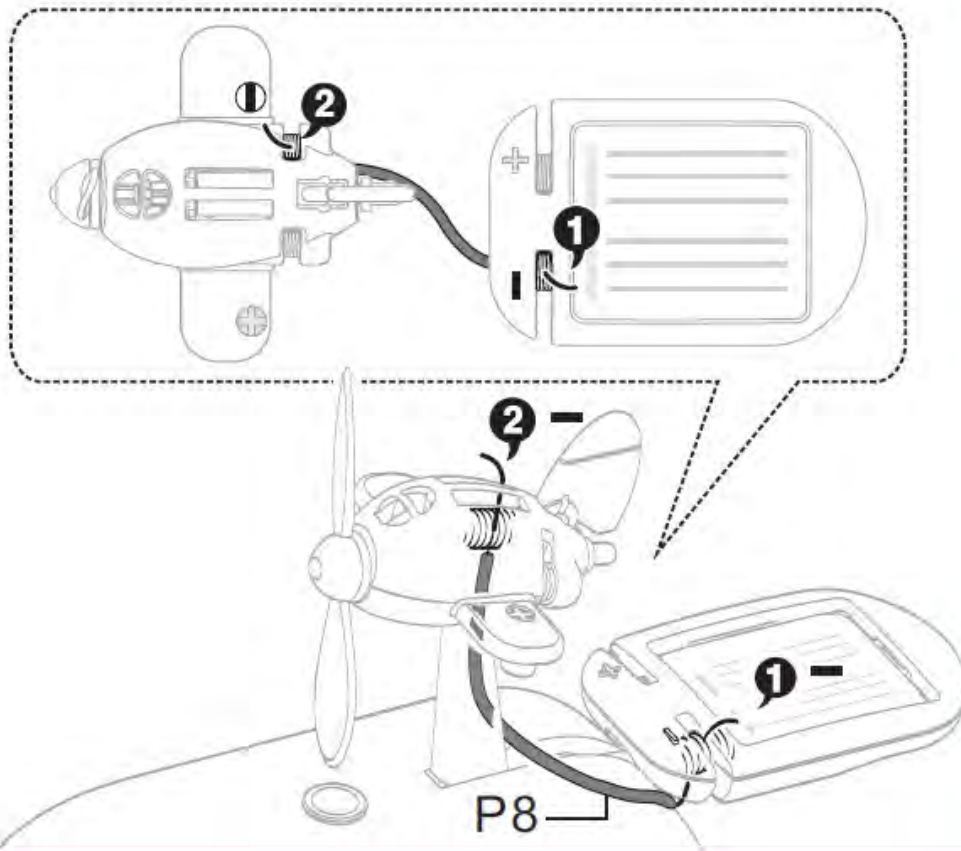

PAS
5

Mòdul solar + CONNECTAR + Motor reductor

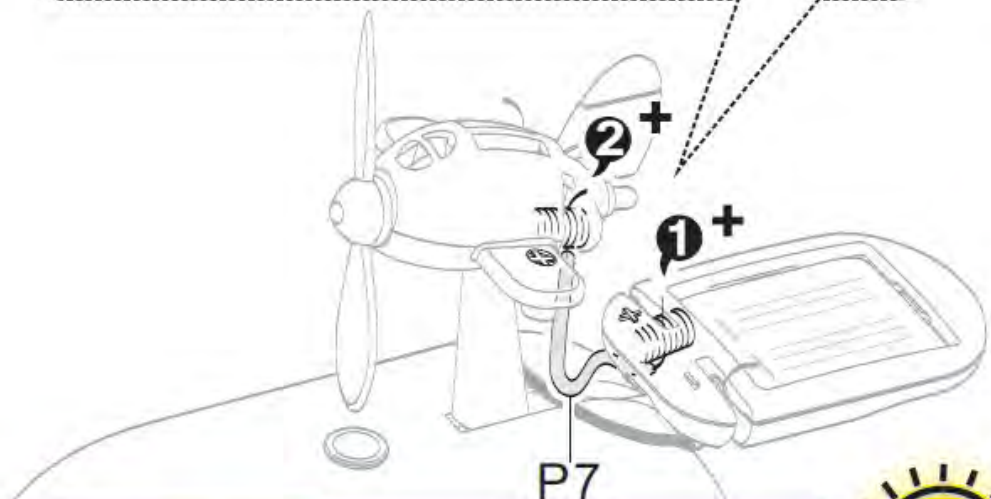
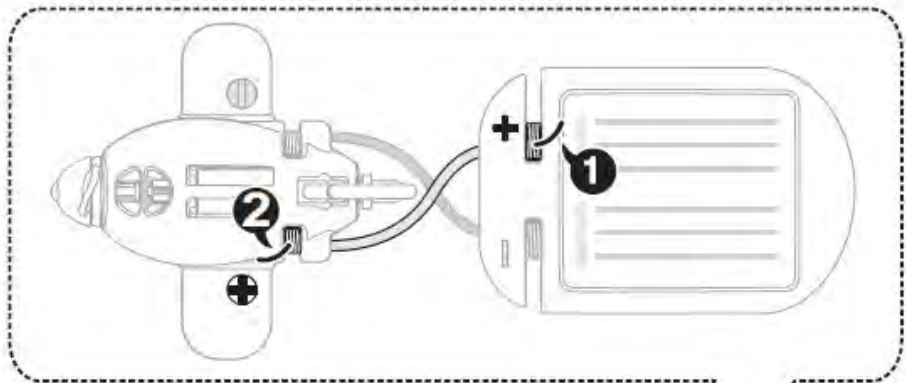

PAS
6

Muntatge finalitzat





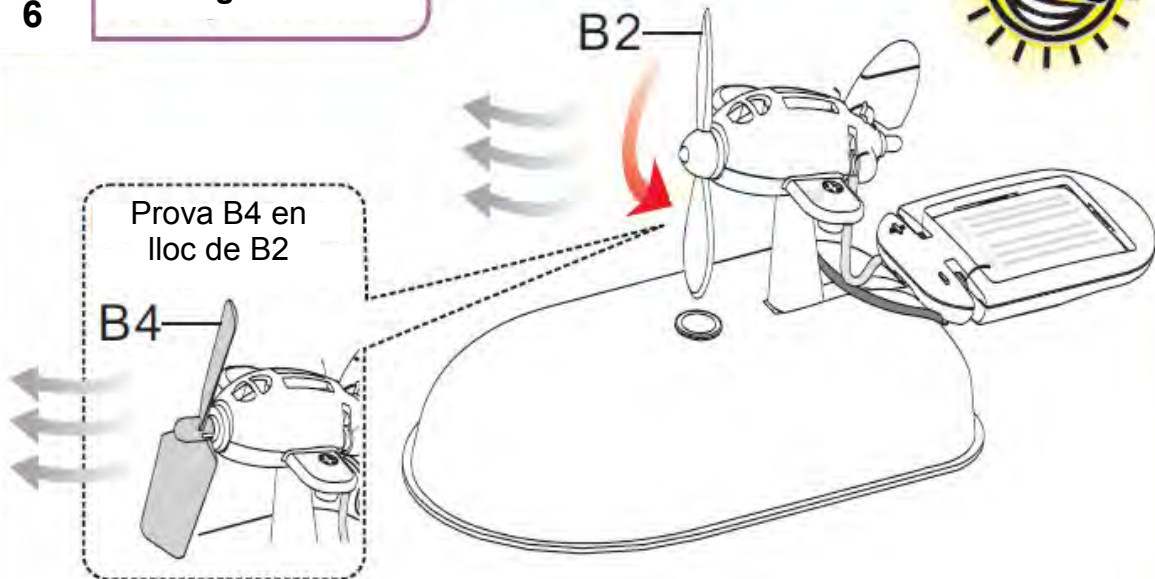
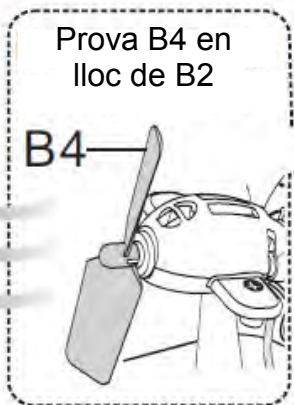







B2

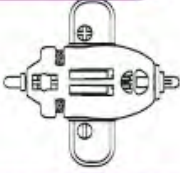

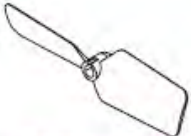
AEROBARCA SOLAR

Peces necessàries

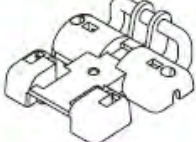
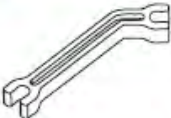

			
Mòdul solar	Motor reductor	P7	P8
			
B4	B9	B11	B12
			
B8	A2	A10	A7

PAS 1

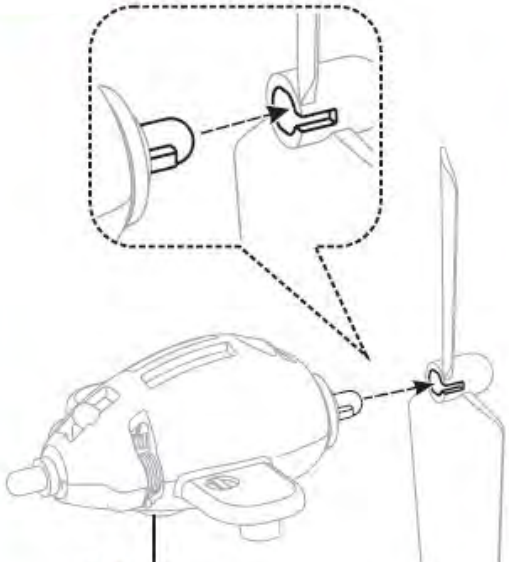

Motor reductor

B4

PAS 2

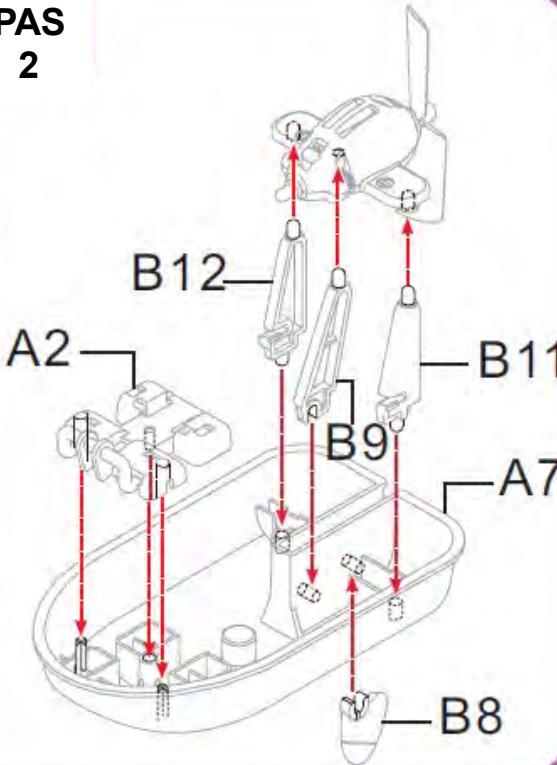

B12

A2

B11

B9

A7

B8

PAS
3

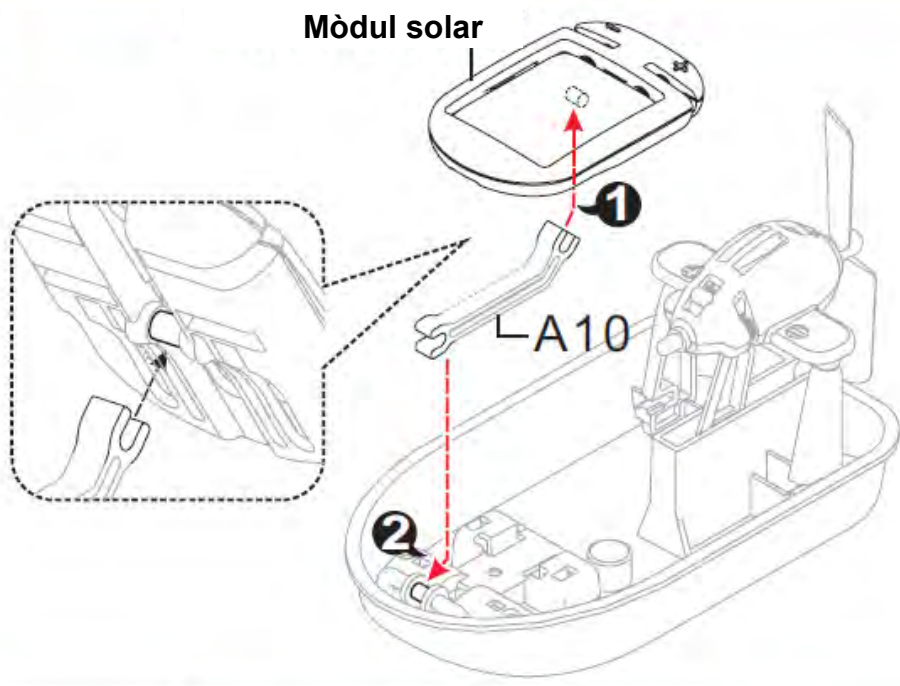

PAS
4

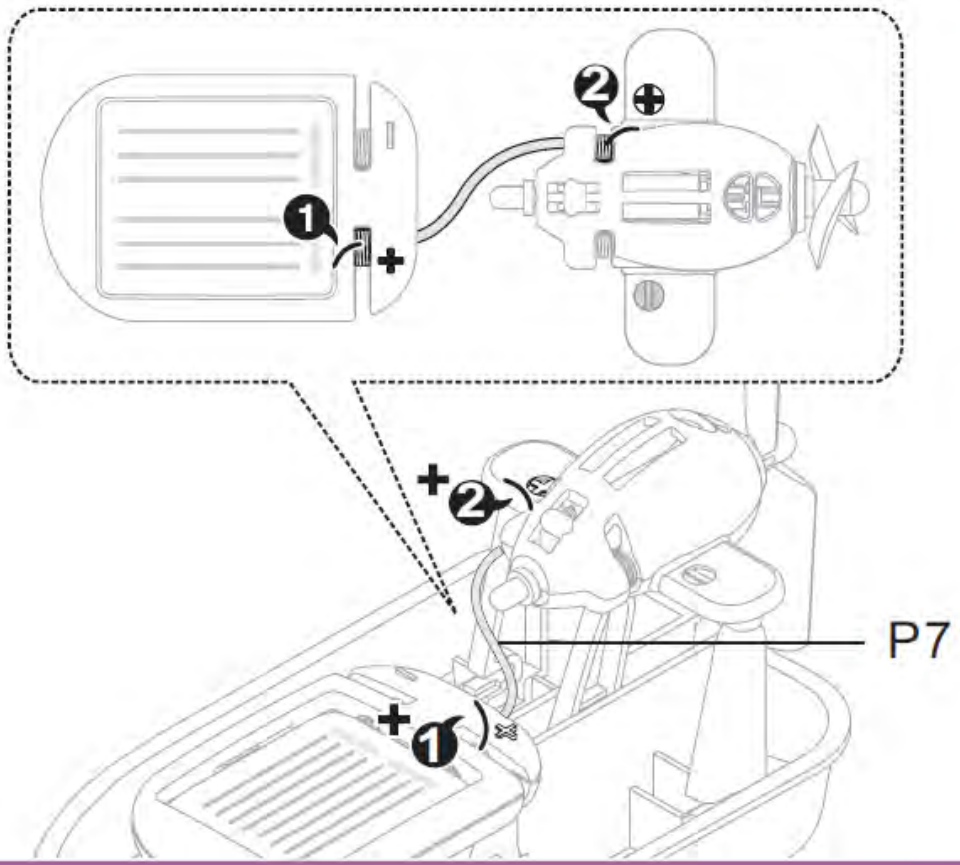
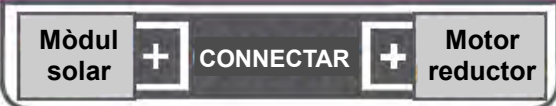

**PAS
5**

Mòdul
solar

CONNECTAR

Motor
reductor

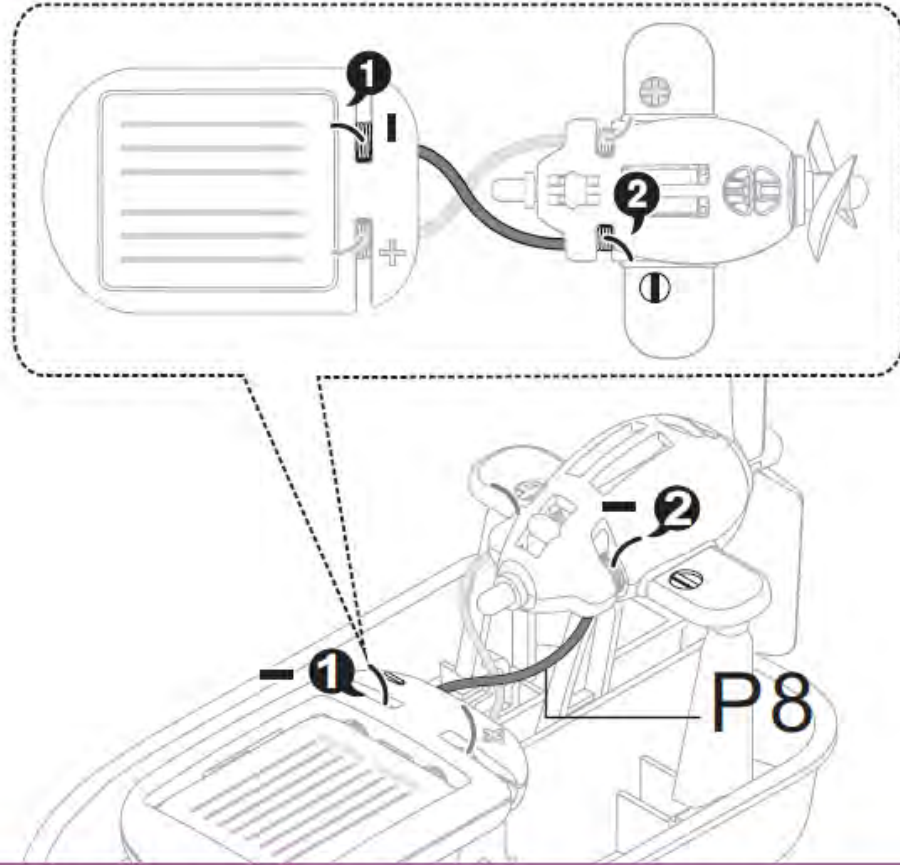

**PAS
6**

Muntatge finalitzat

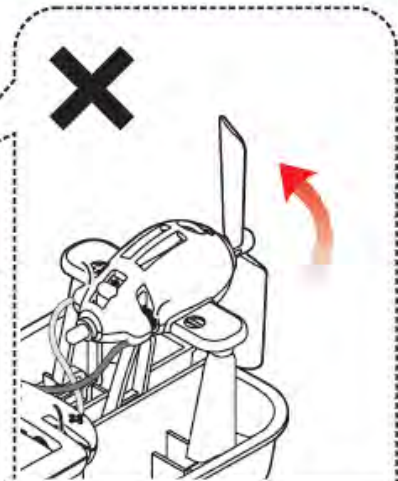









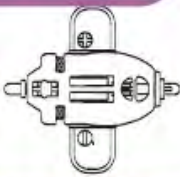

¿Gira al revés?
verifica passos 4 i 5

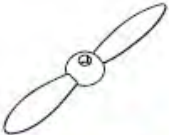

**RO-
BOTICA**
ROBOTICA EDUCATIVA & PERSONAL

AVIÓ GIRATORI SOLAR

Peces necessàries

 Mòdul solar	 Motor reductor	 P9		
 B2	 B8	 P10		 B1
 A7	 A6	 A10		 Moneda (No inclosa)
 A1				

PAS 1

The diagram illustrates the first assembly step. It shows a solar module being connected to a reduction motor. Beam A10 is used to connect the solar module to beam A6. Beam A1 is used to connect beam A6 to the motor. The steps are numbered 1 and 2.

Mòdul solar

A10

1

2

A6

A1

Motor reductor

PAS
2

Mòdul solar - CONNECTAR + Motor reductor

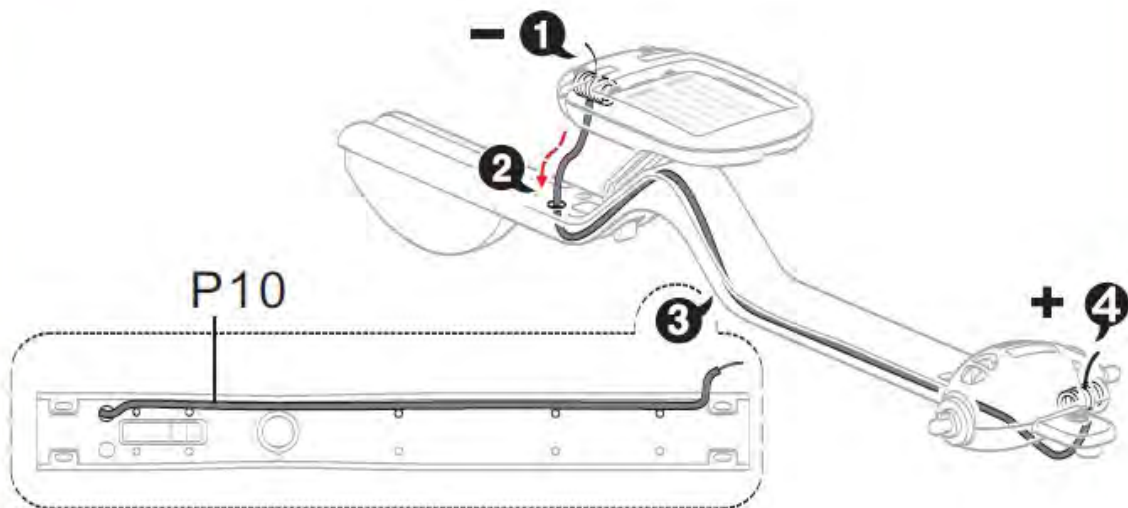

PAS
3

Mòdul solar + CONNECTAR - Motor reductor

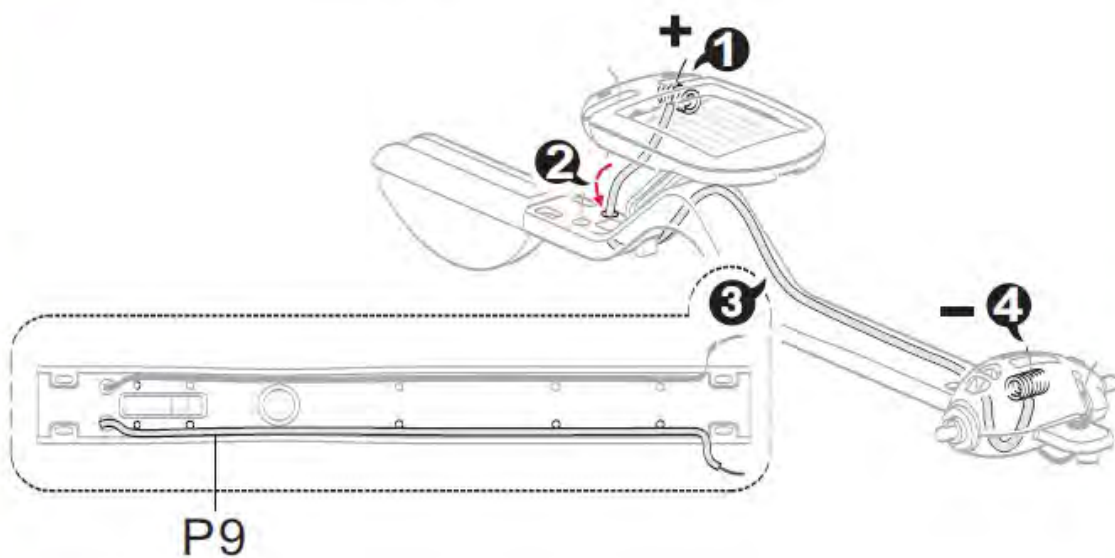

PAS 4

PAS 5 **Com jugar?**

(1°) Inserir una moneda

(2°) Ajustar el mòdul solar per equilibrar la palanca

PAS 6 **Muntatge finalitzat**

Si gira al revés revisi passos 2 i 3

MASCOTA SOLAR



Peces necessàries



Mòdul solar

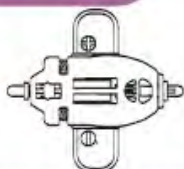

Motor reductor



P7



P8



B9



B10



B11



B12



B8

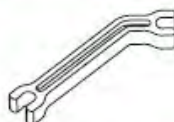

A10

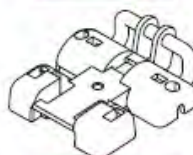

A2

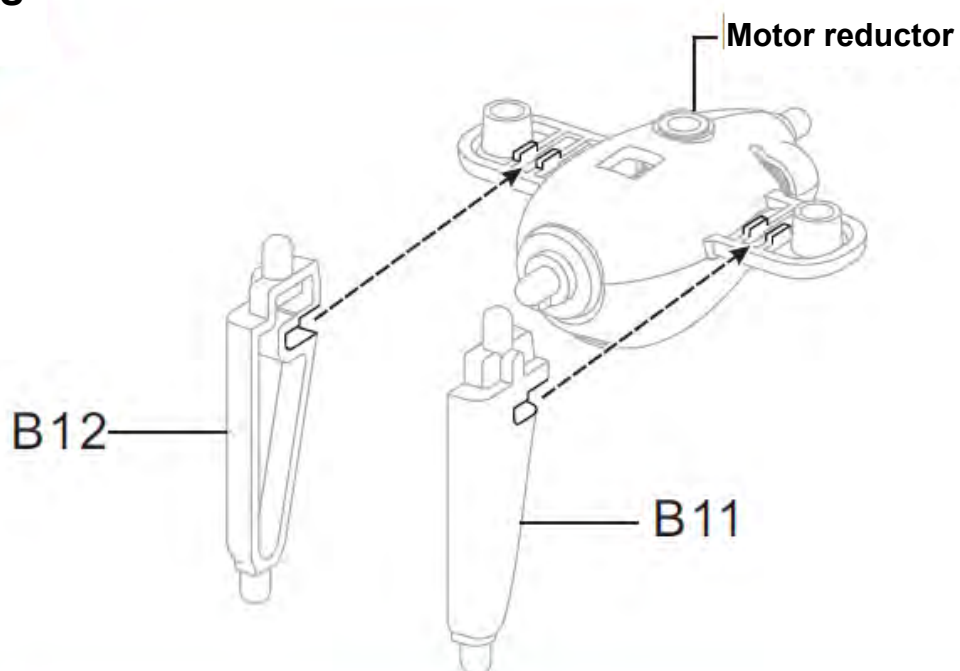
PAS
1

**PAS
2**

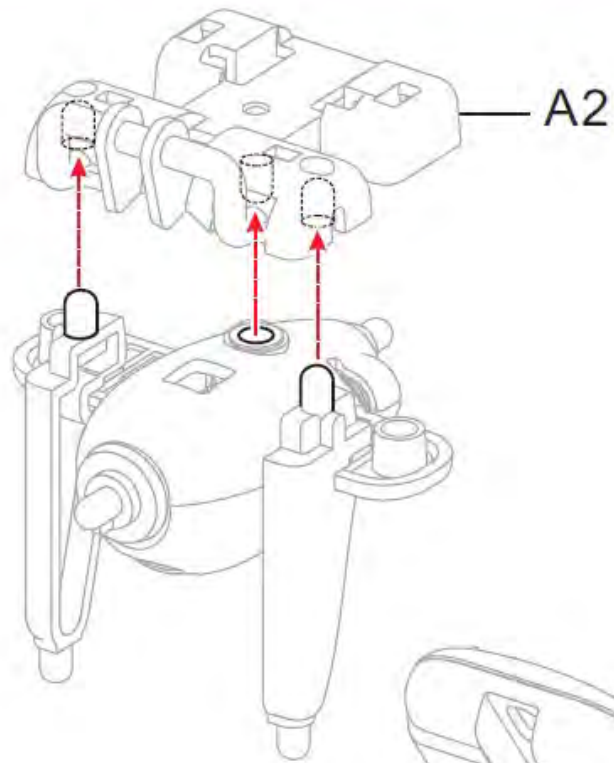

**PAS
3**

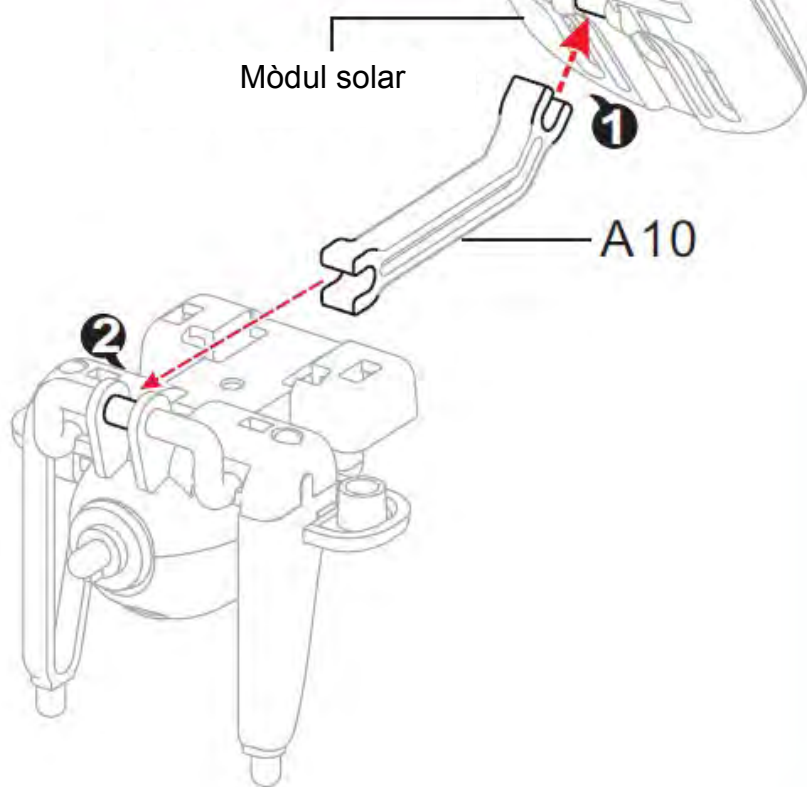

PAS 4

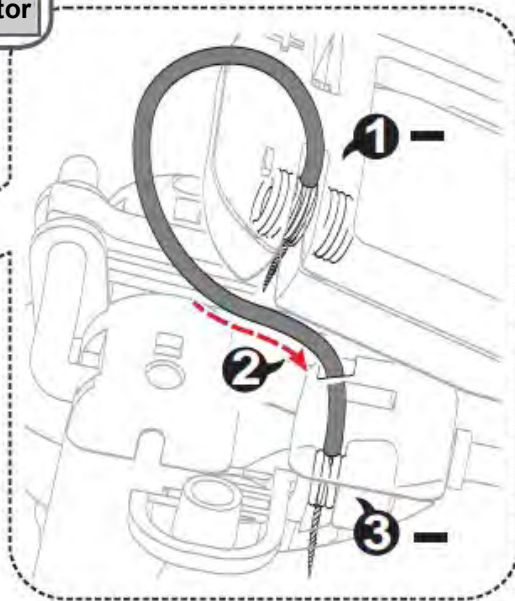
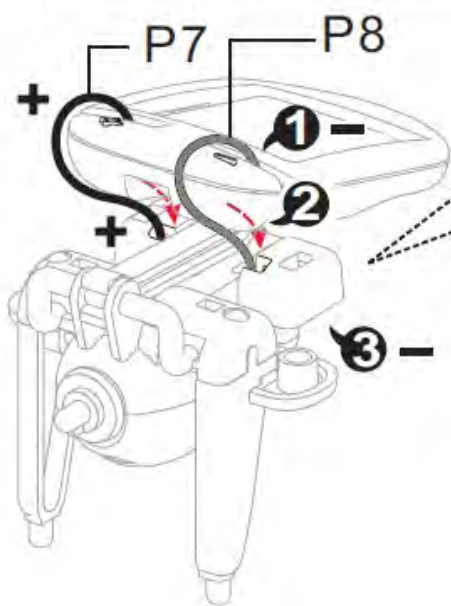

PAS 5

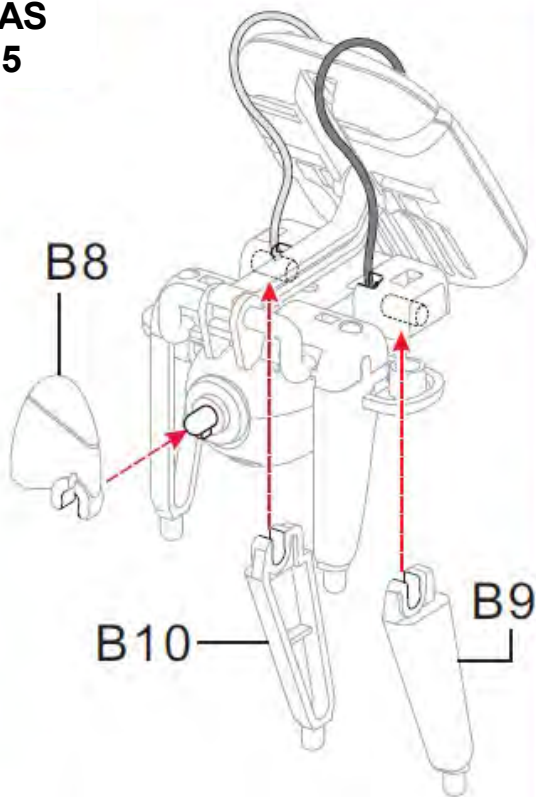

PAS 6







Muntatge finalitzat

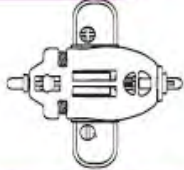

COTXE SOLAR

Peces necessàries

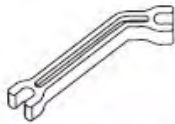
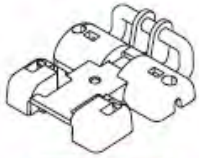

			
Mòdul solar	Motor reductor	P7	P8
			
P4	B7x2	B6x2	A10
			
A2			

PAS 1

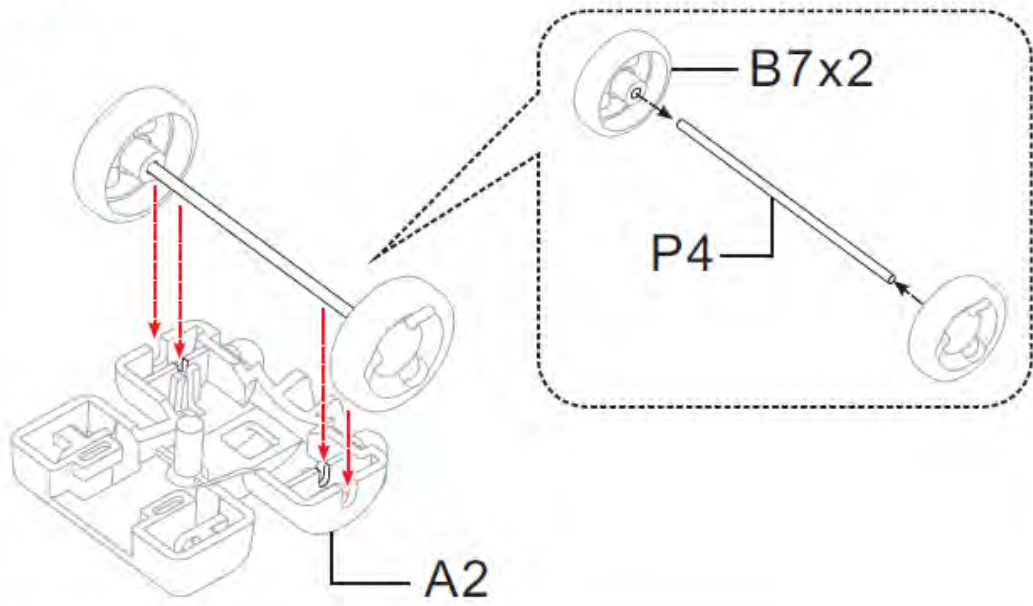

The diagram illustrates the first assembly step. A motor (B6x2) is being inserted into a bracket (A2). A pin (P4) is inserted through the motor's axle into a wheel (B7x2). A callout box provides a close-up of the pin (P4) passing through the motor axle and the wheel (B7x2).

PAS
2

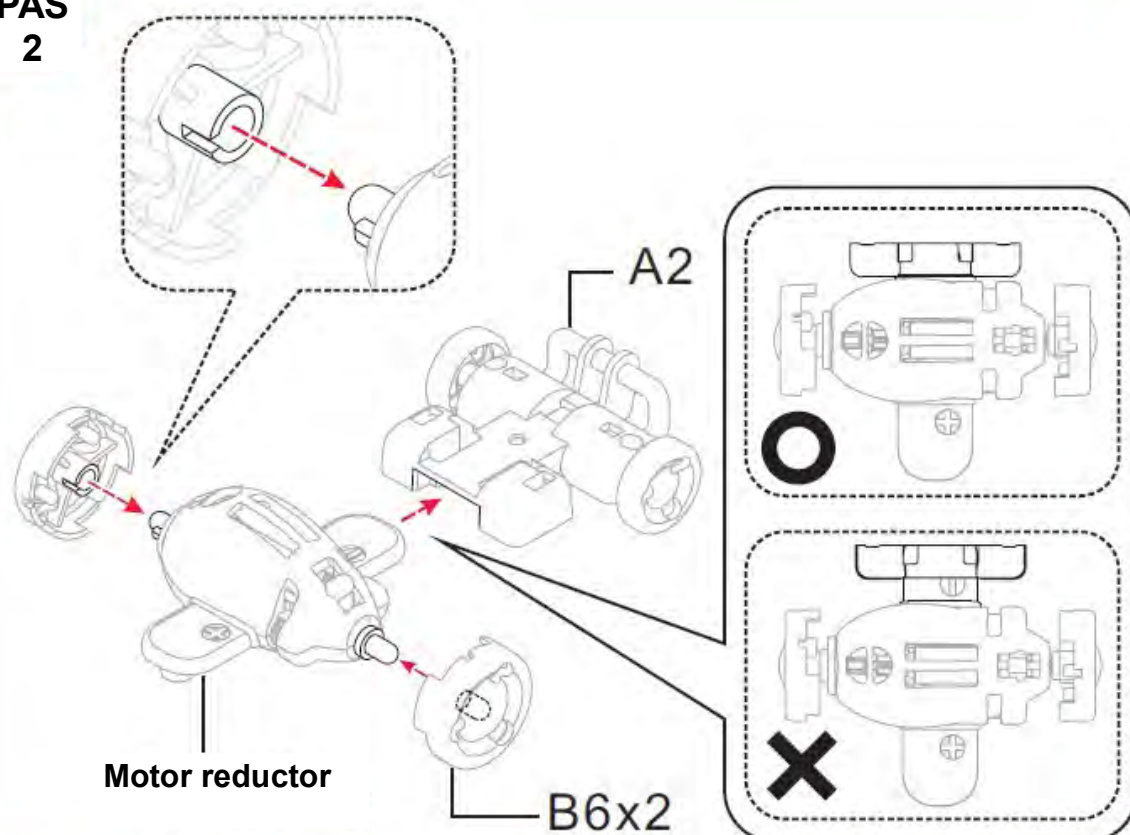

PAS
3

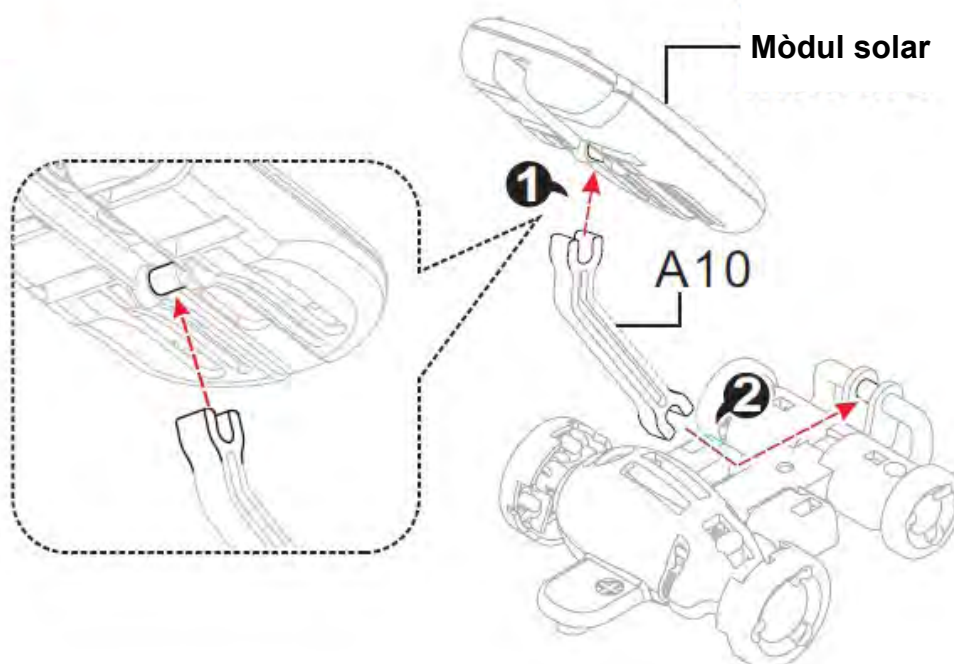

PAS 4

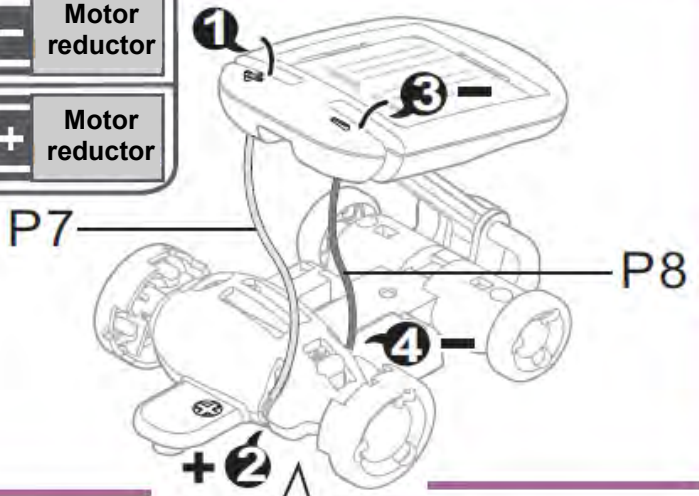
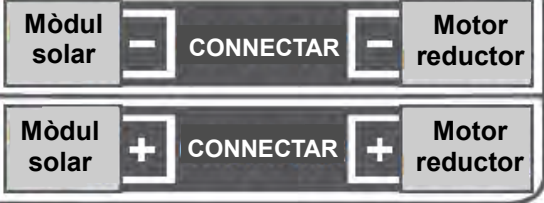

PAS 5

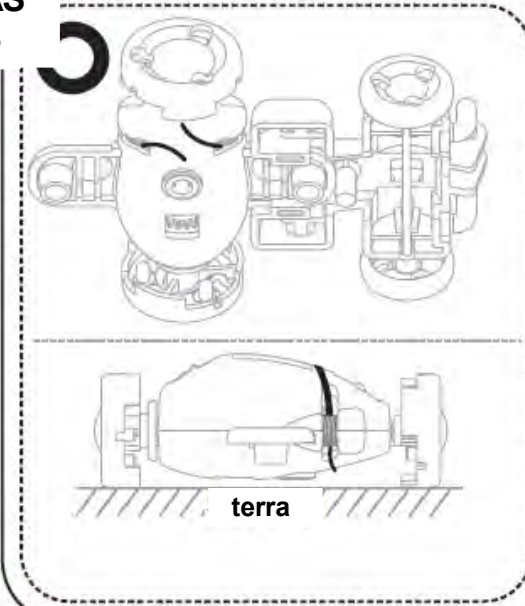

PAS 6

Muntatge finalitzat



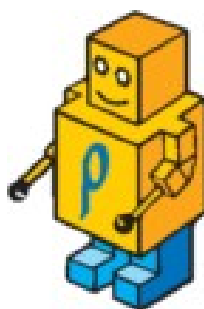

**RO-
BOTICA**
ROBOTICA EDUCATIVA & PERSONAL

- Situeu el model muntat a l'exterior, sota la llum directa del sol. Els millors resultats s'obtenen en un dia assolellat.
- Si voleu provar-ho en l'interior utilitzeu una bombeta halògena de 50W o més, com a focus lluminós.
- Aquest dispositiu no funciona amb la llum d'un dia ennuvolat, ni en zones d'ombra, llum solar indirecta o llum fluorescent.

NOTA: Aquest kit està recomanat per a nens a partir de 10 anys, sempre acompanyat per un adult



**RO-
BOTICA**
ROBOTICA EDUCATIVA & PERSONAL