













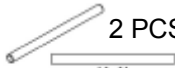

### RANA SOLAR C-9972



#### MATERIAL INCLUIDO

- |   |   |  |
|---|---|--|
| Panel solar con motor<br>1 PC  | Piñón (blanco)<br>1 PC   | Engranaje (rojo)<br>1 PC  |
| Engranaje (amarillo)<br>2 PCS  | Engranaje con eje<br>1 PC  | Eje cilíndrico<br>2 PCS   |
| Muelle<br>1 PC                 | Tornillo<br>2 PCS          | Arandela<br>2 PCS           |
| España<br>1 PC                 | oios<br>2 PCS            | Pies de goma<br>1 PC      |
|   |   | Eje exagonal<br>1 PC      |

#### Piezas de plástico



#### Herramienta necesaria :



Destornillador con punta estrella

#### Instrucciones de montaje

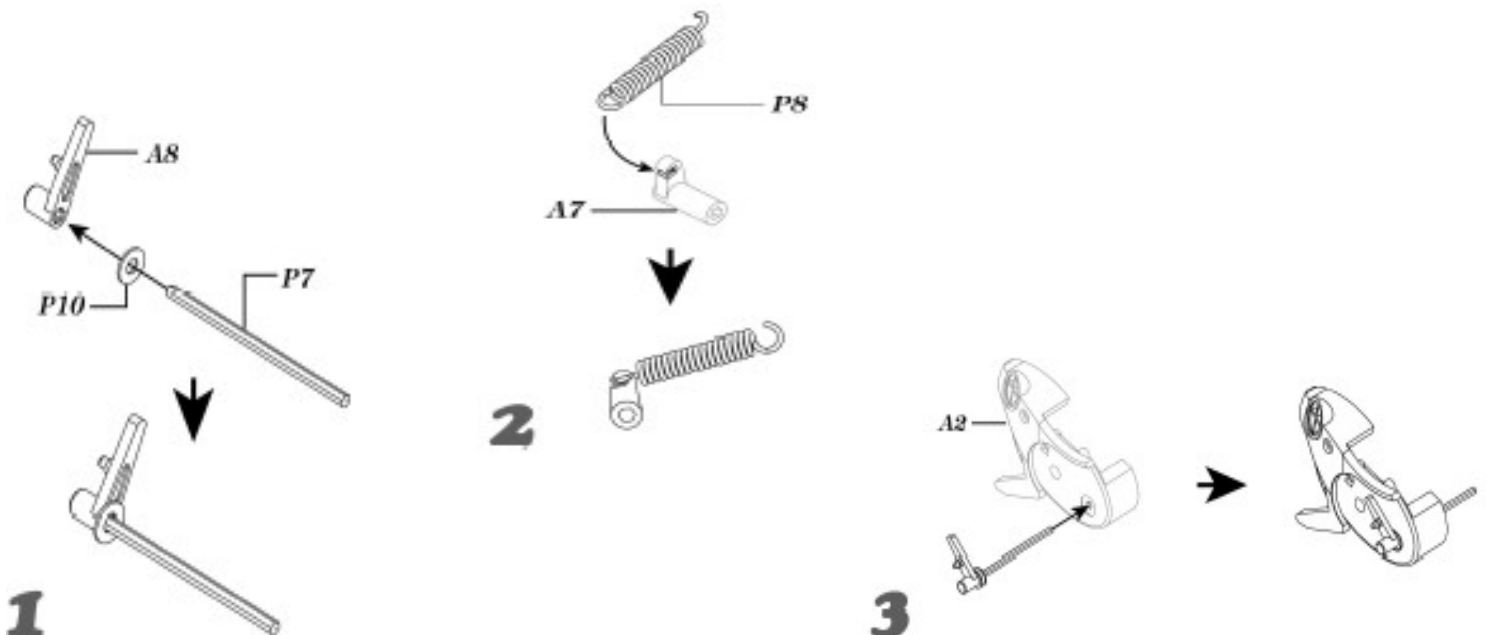

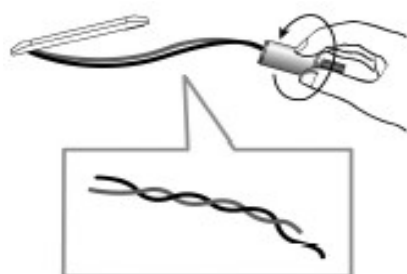
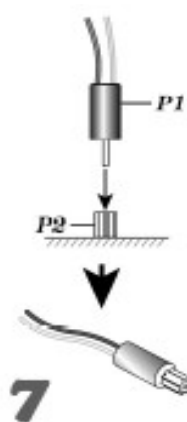
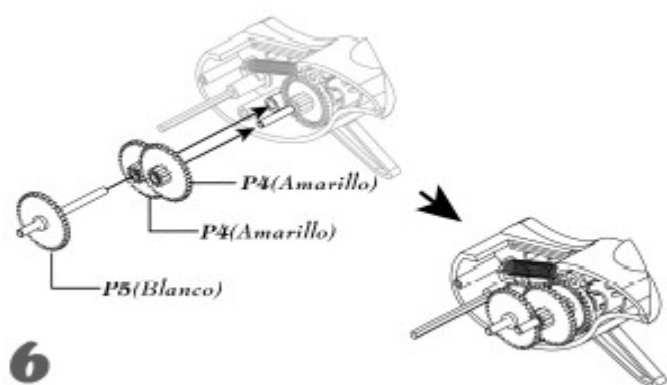
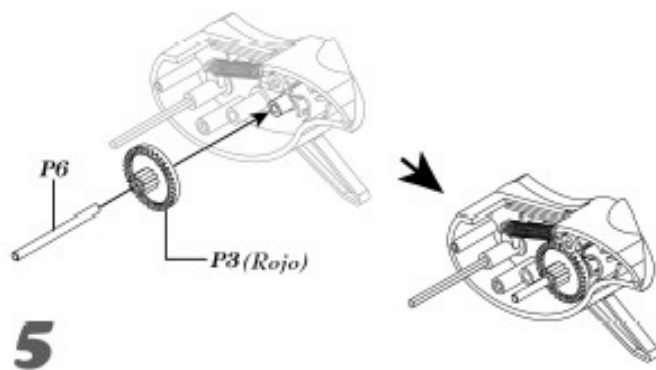
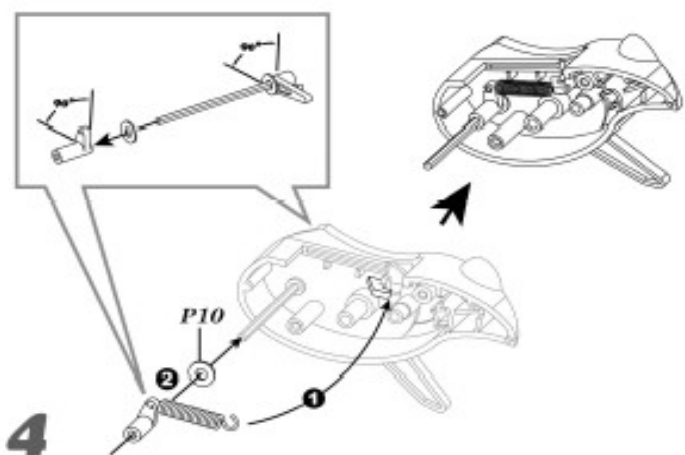

**8** Enrollar los cables con cuidado

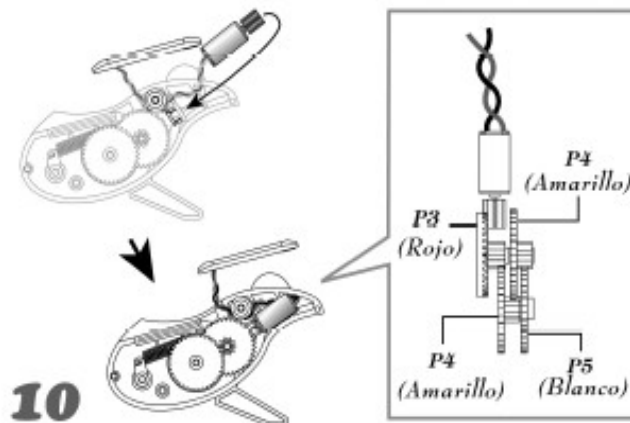
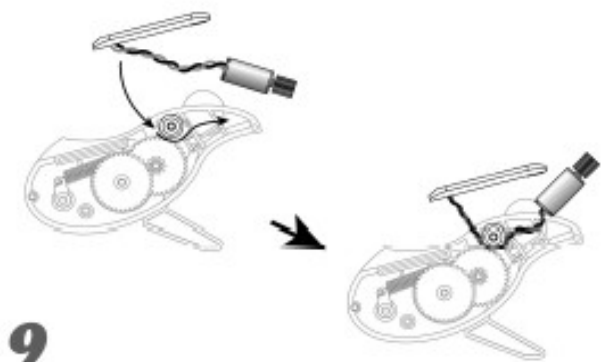

**RO-  
BOTICA**  
ROBOTICA EDUCATIVA & PERSONAL

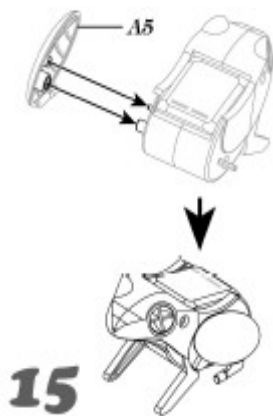
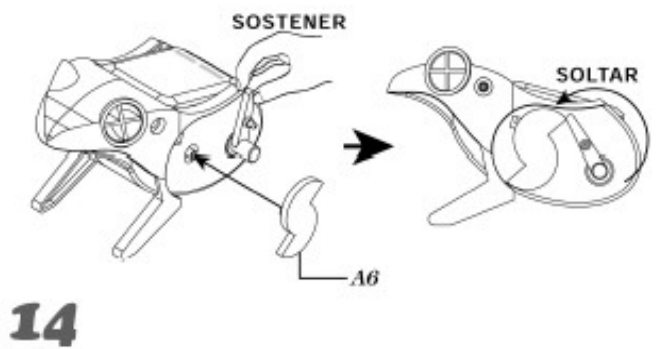
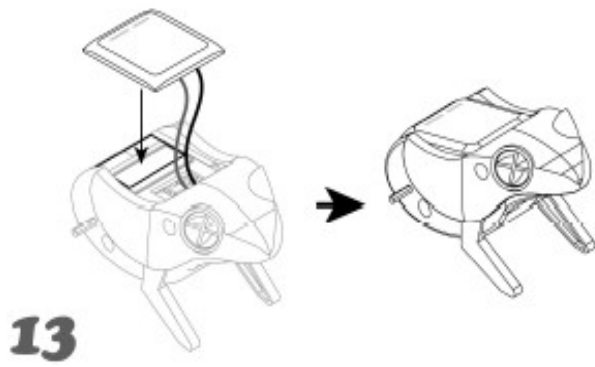
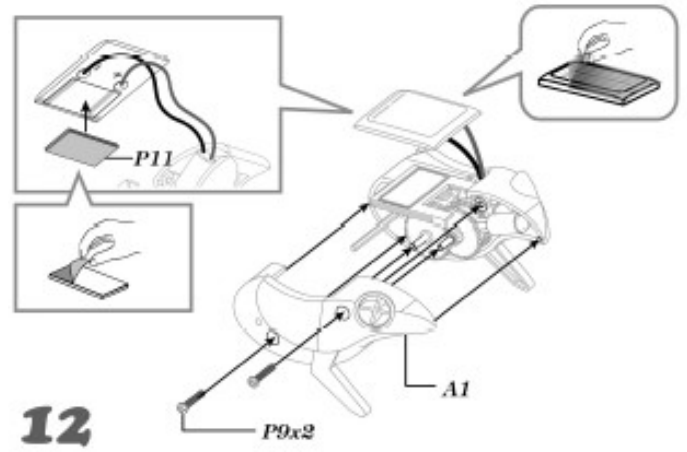
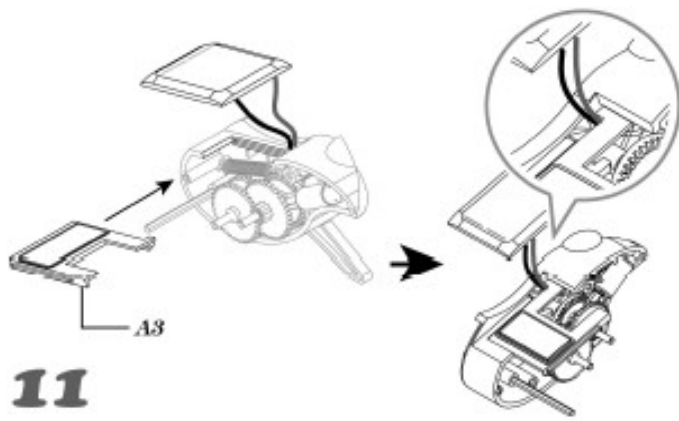

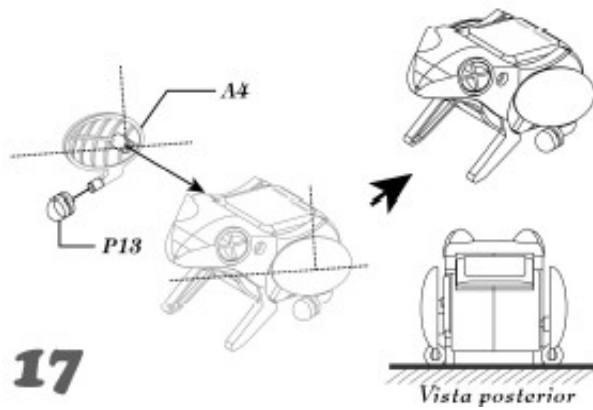
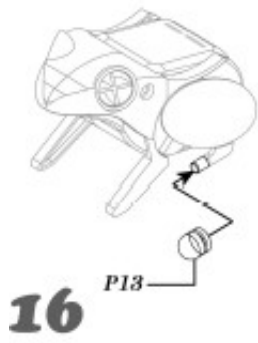

**19** Producto finalizado

**NOTA :** Este kit esta recomendado para niños a partir de 8 años, acompañados siempre por un adulto

**ATENCIÓN**  Este kit contiene piezas pequeñas

 Video del montaje paso a paso en youTube



**RO-  
BOTICA**  
ROBOTICA EDUCATIVA & PERSONAL