

Einzelteilübersicht / Spare parts list / Liste des pièces détachées / Onderdelenoverzicht / Lista da piezas / Resumo de peça individual /
Singoli componenti / Отдельные детали / 零件概览 2

Montagetips / Tips for assembly / Tuyaux pour le montage / Montagetips / Consejos para el montaje / "Dicas" para montagem /
Consigli per il montaggio / Советы по сборке / 装配建议 3

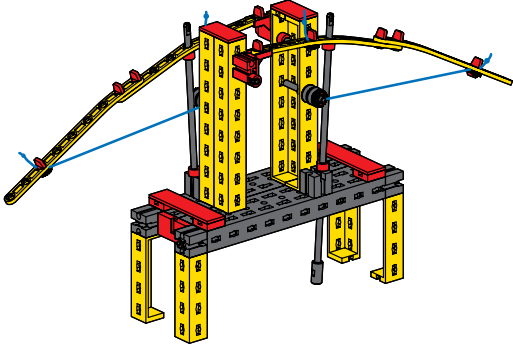

Mechanische Flügel / Mechanical wings / Ailes mécaniques /
Mechanische vleugel / Alas mecánicas / Asa mecânica /
Ali meccaniche / Механические крылья / 机翼 4

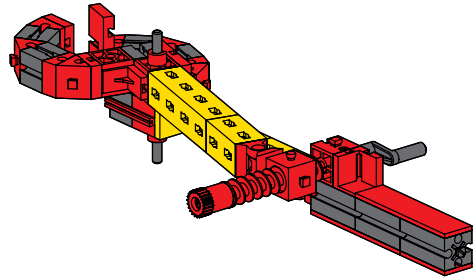

Schmiedezange / Blacksmith's tongs / Tenaille à forge / Smeedtang /
Tenazas de forja / Alicates de ferro / Tenaglie da fucinatore /
Кузнечные клещи / 锻钳 7

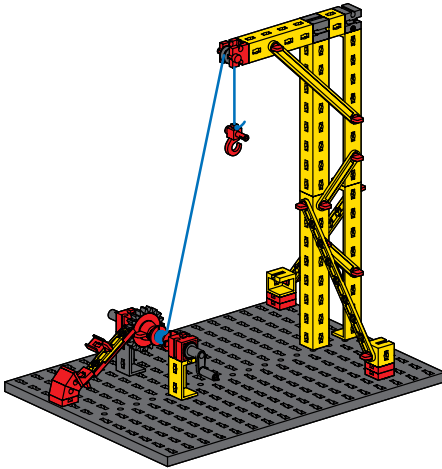

Kran mit Sperrklinke / Crane with pawl / Grue avec cliquet d'arrêt / Kraan met
blokkeerpal / Grúa con trinquete de parada / Guincho com lâmina de bloqueio /
Gru con ingranaggio di arresto / Кран со стопорной защелкой /
带有止动爪的吊车 9

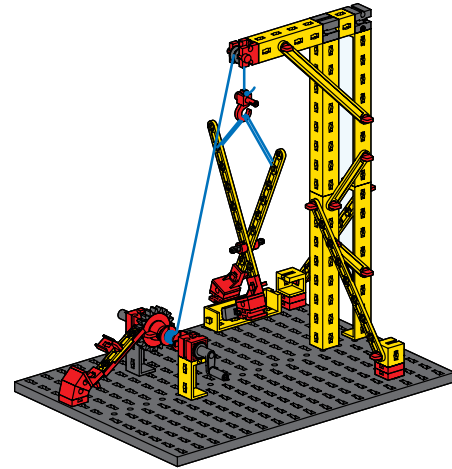

Steinzange / Stone tongs / Tenaille à pierre / Steentang / Horca de rocas /
Alicates de pedras / Tenaglie per pietra / Захват для подъема камней /
石钳以及自动松开的钩子 14

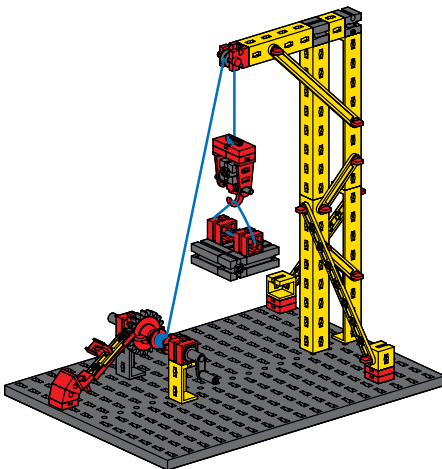

Selbstlösender Haken / Self-releasing hook / Crochet à déclenchement
automatique / Zelfontgrendelende haak / Gancho autosoltante /
Gancho de autodisparo / Gancho con autoscatto /
саморасцепляющийся крюк / 石钳以及自动松开的钩子 16

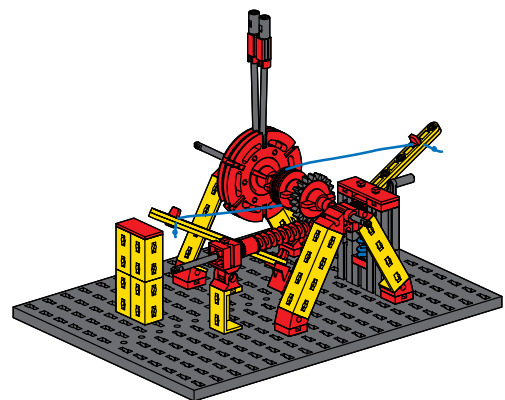

Katapult / Catapult / Catapulte / Katapult / Catapulta / Catapulta /
Catapulta / Катапульта / 弹射器 18

Inhalt
Contents
Contenu

Inhoud
Contenido
Conteúdo

Contenuto
Содержание
目录

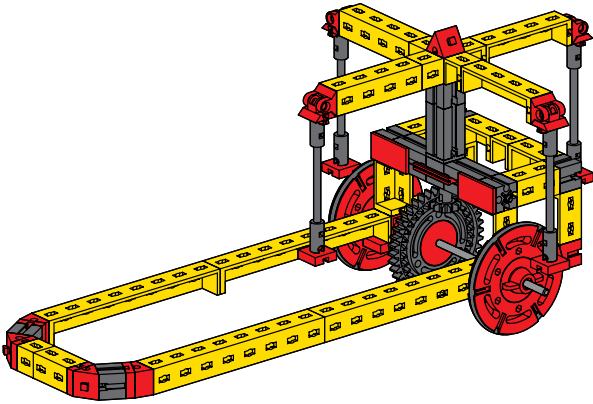

Streitwagen / Chariot / Char / Strijdwagen / Carro de combate / Carro de guerra / Carro da guerra / Боевая колесница / 战车 23

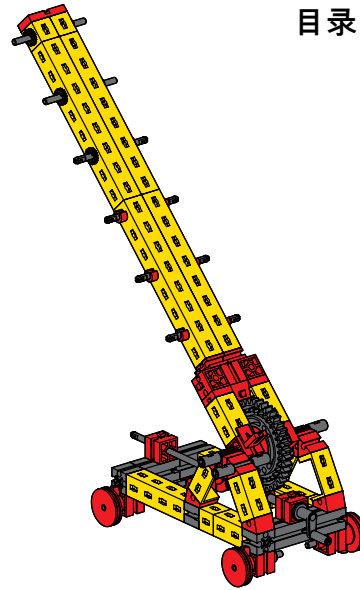

Sturmleiter / Scaling ladder / Echelle d'assaut / Stormladder / Escalera de asalto / Escada de assalto / Scala d'assalto / Штурмовая лестница / 突击梯 26

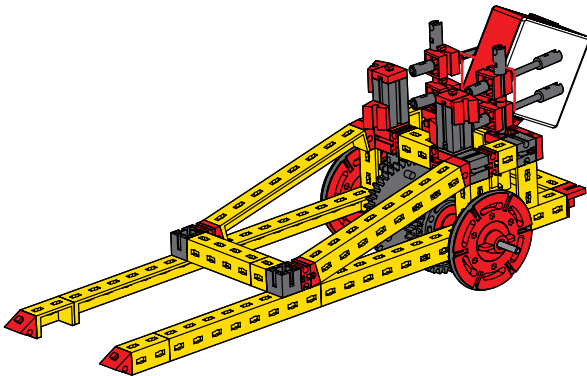

Trommelwagen / Drum wagon / Char à tambour / Trommelwagen / Carro de tambores / Carro de tambores / Carro a tamburo / Тележка с барабаном / 擂鼓车 29

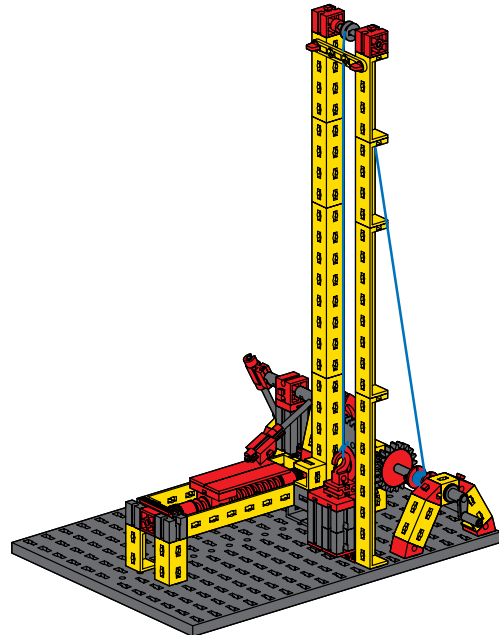

Feilenhaumaschine / File cutting machine / Tailleuse de mines / Vlijenkapmachine / Tajadora de limas / Máquina de grosas / Macchina taglialime / Машина для насечки напильников / 制锉机 34

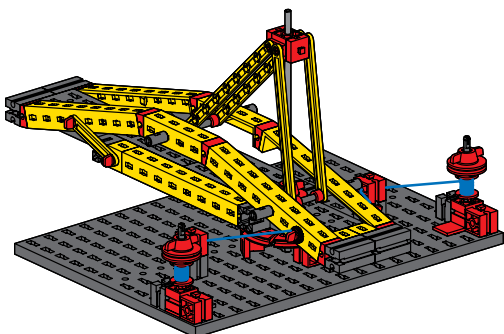

Drehbrücke / Swing bridge / Pont pivotant / Draaibrug / Puente giratorio / Ponte giratória / Ponte girevole / Поворотный мост / 旋转桥 43



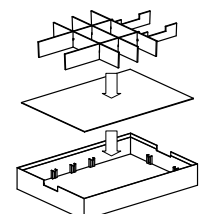







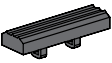

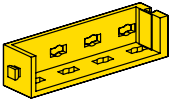





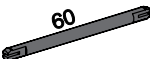



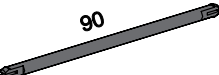







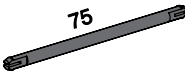







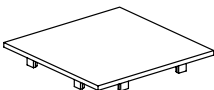

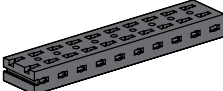



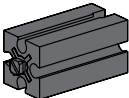
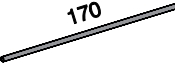
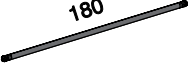





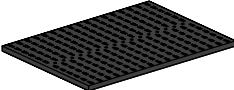

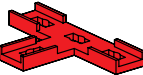
Sortiervorschlag für Aufbewahrungssystem / Storage suggestion for storage system / Suggestion de classement pour le système de stockage / Sorteervoorstel voor bewaarsysteem / Propuesta de clasificación para almacenamiento / Proposta de divisão caixa 1 para sistema de conservação / Proposta di sistemazione per il sistema di conservazione / Способ сортировки для хранения / 保存系统的分类建议

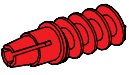
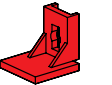

Einzelteilübersicht
Spare parts list
Liste des pièces détachées

Onderdelenoverzicht
Lista da piezas
Resumo de peça individual

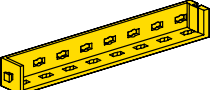
Singoli componenti
Отдельные детали
零件概览

 60° 31 010 6 x	 31 790 2 x	 120 35 060 4 x	 36 297 4 x
 30° 31 011 4 x	 31 891 1 x	 30 35 063 1 x	 36 298 5 x
 31 016 2 x	 31 892 1 x	 60 35 065 4 x	 36 299 11 x
 31 019 2 x	 31 915 2 x	 90 35 066 2 x	 4 36 323 14 x
 31 021 1 x	 15° 31 981 8 x	 35 073 4 x	 6 36 324 2 x
 31 022 2 x	 31 982 7 x	 75 35 087 2 x	 36 334 6 x
 31 027 1 x	 32 064 10 x	 35 088 1 x	 36 819 2 x
 31 058 5 x	 32 850 4 x	 35 360 1 x	 37 237 9 x
 30 31 061 2 x	 32 854 2 x	 35 678 2 x	 37 468 6 x
 31 426 4 x	 32 879 4 x	 170 35 696 1 x	 180 37 527 2 x
 31 436 4 x	 32 881 6 x	 35 945 2 x	 37 636 1 x
 31 597 8 x	 32 985 1 x	 35 975 2 x	 37 679 10 x
 31 672 1 x	 35 031 5 x	 36 010 1 x	 37 858 2 x
 31 674 3 x	 35 053 4 x	 36 227 8 x	 37 925 1 x
 31 690 2 x	 106 35 059 2 x	 36 294 6 x	 37 926 1 x

Einzelteilübersicht
Spare parts list
Liste des pièces détachées

Onderdelenoverzicht
Lista da piezas
Resumo de peça individual

Singoli componenti
Отдельные детали
零件概览

	38 225 1 x		38 260 2 x		38 423 3 x		38 542 2 x
	38 240 2 x		38 277 1 x		38 428 3 x		128 659 2 x
	38 241 2 x		38 414 4 x		38 464 2 x		130 593 2 x
	38 258 4 x		38 416 2 x		38 541 1 x		130 961 1 x

Montagetipps
Tips for assembly
Tuyaux pour le montage

Montagetipps
Consejos para el montaje
"Dicas" para montagem

Consigli per il montaggio
Советы по сборке
装配建议

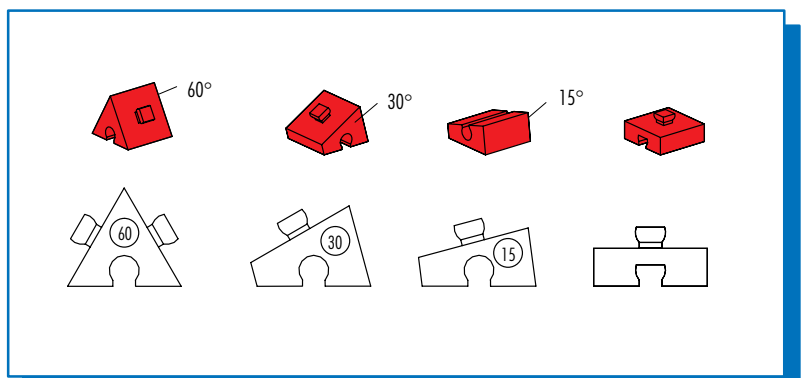
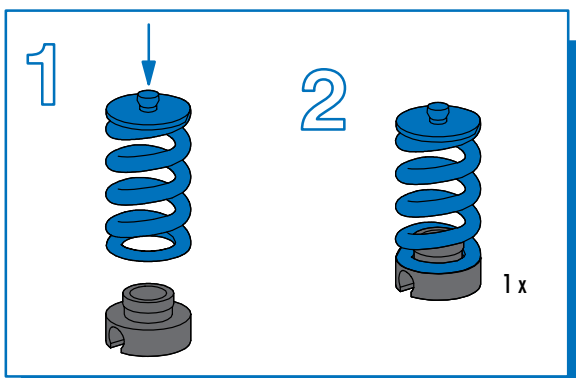
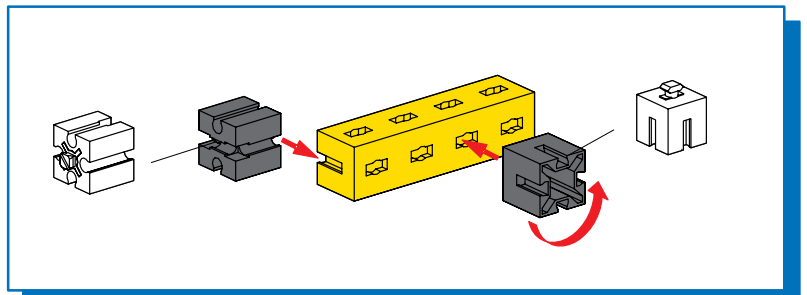
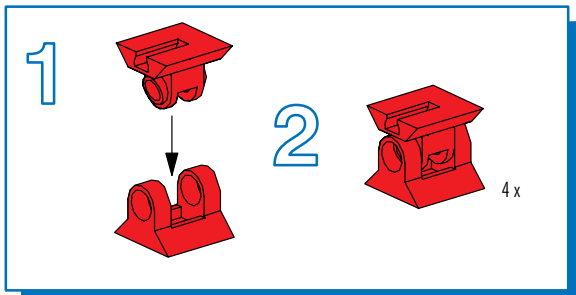

<p>Seile Cables Câbles</p>	<p>Touwen Cables Cordas</p>	<p>Funi Канаты 绳索</p>			<p>Knoten verhindert ausfransen Knots prevent fraying Le noeud empêche l'effilochage Knopen voorkomen het uitrafelen Nudos impiden el deshilachado Não para evitar a desintegração da corda Il nodo impedisce la sfilacciatura Узлы не дают канатам разлохматиться 节点可以防止散线</p>
---	--	--------------------------------------	--	--	---

- Alle Einzelteile, insbesondere bewegliche Teile sind falls notwendig zu warten und zu reinigen.
- Es necesario limpiar y mantener en buen estado todas las diferentes piezas - especialmente las piezas móviles.
- Toutes les pièces détachées et en particulier les pièces mobiles, sont, si nécessaire, à entretenir et à nettoyer.
- Caso necessário, todas as peças individuais, especialmente peças móveis, tem que ser submetidas à manutenção e ser limpidas.
- Alle onderdelen, vooral de bewegende delen, kunnen, indien noodzakelijk, onderhouden en gereinigd worden.
- Se necessario, tutti i singoli componenti, soprattutto le parti mobili, si devono eventualmente sottoporre a manutenzione e pulizia.
- Все детали, особенно подвижные, требуют ухода и чистки.
- 必要时应保养和清洁所有零件, 尤指运动部件。