

Inhalt
Contents
Contenu

Inhoud
Contenido
Conteúdo

Einzelteilübersicht / Spare parts list / Liste des pièces détachées / Onderdelenoverzicht / Lista da piezas / Resumo de peça individual /
Singoli componenti / Перечень деталей / 零件概览 2

Montagetipps / Tips for assembly / Tuyaoux pour le montage / Montagetips / Consejos para el montaje / "Dicas" para montagem /
Consigli per il montaggio / Советы по сборке / 装配建议 3

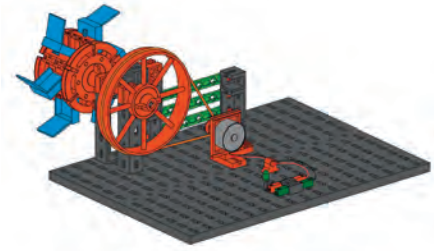
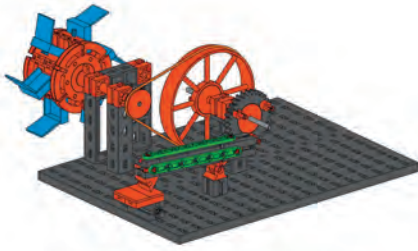

Hammerschmiede / Hammer mill / Forges à marteaux-pilons /
Hamersmederij / Forja de martillo pilón / Forja de martelos / Fucina /
Кузнечный молот / 锤锻5

Wasserturbine / Water turbine / Turbine hydraulique / Waterturbine /
Turbina de agua / Turbina hidráulica / Turbina idraulica /
Гидротурбина / 水轮机9

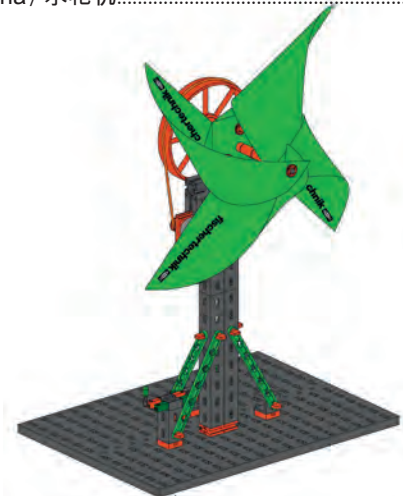

Windrad mit Pumpe / Windmill with pump / Roue éolienne avec pompe /
Wieken met pomp / Rueda de viento con bomba / Turbina eólica com
bomba / Pala eolica con pompa / Ветряное колесо с насосом /
风车和泵12

Windkraftanlage / Windpower Station / Éolienne / Windkrachtinstallatie /
Instalación eólica / Estación eólica / Impianto eolico / Ветросиловая
установка / 风力发电机18

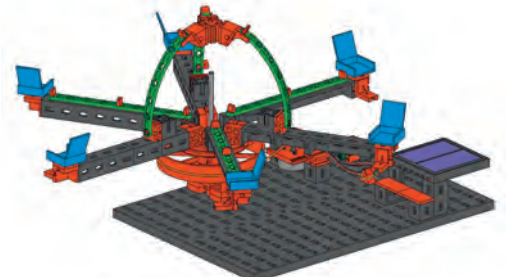
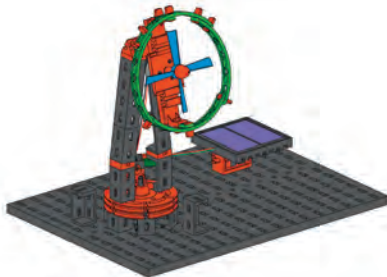

Ventilator / Ventilating fan / Ventilateur / Ventilator / Ventilador / Ventilador /
Ventola / Вентилятор / 风扇23

Karussell / Merry-go-round / Manège / Draaimolen / Tiovivo / Carrossel /
Giostra / Карусель / 旋转木马28

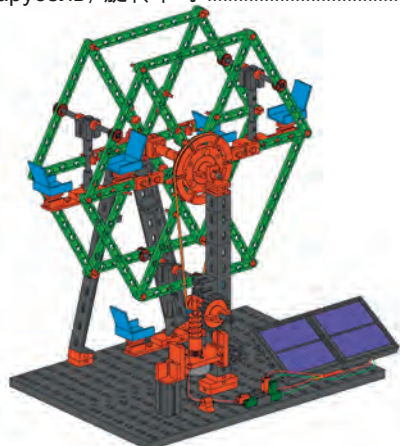
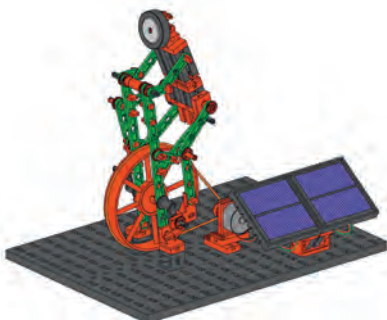

Radfahrer / Bicycle rider / Cycliste / Fietser / Ciclista / Ciclista / Ciclista /
Велосипедист / 骑自行车的人34

Riesenrad / Ferris wheel / Grande roue / Reuzenrad / Rueda gigante /
Roda gigante / Ruota gigante / Колесо обозрения / 大转轮38



Solarfahrzeug / Solar vehicle / Véhicule solaire / Voertuig op zonne-energie / Vehículo solar / Veículo solar / Veicolo ad energia solare / Электромобиль с солнечными батареями / 太阳能电动车.....46

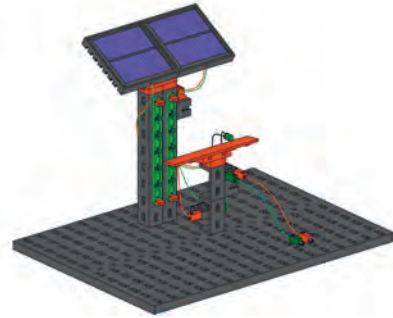

Solartankstelle / Solar charging station / Panneau solaire photovoltaïque / Oplaadstation op zonne-energie / Estación de servicio solar / Posto de abastecimento solar / Pannello solare fotovoltaico / Солнечная зарядная станция / 太阳能充电站.....50



Elektrofahrzeug / Electric vehicle / Véhicule électrique / Elektrisch voertuig / Vehículo eléctrico / Veículo elétrico / Veicolo elettrico / Электромобиль / Электромобиль 电动车.....52

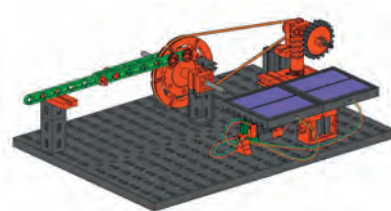

Schranke / Barrier / Barrière / Spoorboom / Barrera / Barreira / Barriera / Шлагбаум / 栏杆.....54

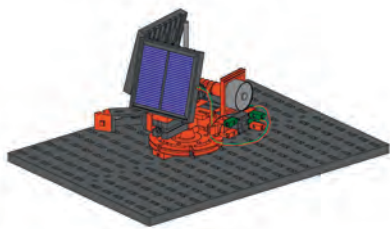

Solarnachführung / Solar tracking / Orientation du panneau solaire / Zonvolgsysteem / Seguimiento solar / Traçamento solar / Orientamento pannelli solari / Слежение за солнцем / 太阳跟踪仪.....58



Ökohaus / Eco-house / Maison écologique / Ecologisch huis / Casa ecológica / Casa ecológica / Eco casa / Эко-дом / 生态房屋.....61

Sortiervorschlag für Aufbewahrungssystem / Storage suggestion for storage system / Suggestion de classement pour le système de stockage / Sorteervoorstel voor bewaarsysteem / Propuesta de clasificación para almacenamiento / Proposta de divisão caixa 1 para sistema de conservação / Proposta di sistemazione per il sistema di conservazione / Рекомендации по сортировке для системы хранения / 保存系统的分类建议

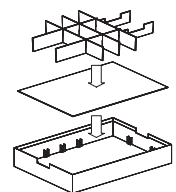

Profi Oeco Energy + Fuel Cell Kit77

Einzelteilübersicht
Spare parts list
Liste des pièces détachées

Onderdelenoverzicht
Lista da piezas
Resumo de peça individual

	19 317 1 x		31 690 3 x		32 985 1 x		36 323 24 x
	31 010 2 x		31 848 6 x		34 995 2 x		36 324 12 x
	31 011 3 x		31 915 2 x		35 031 5 x		36 334 15 x
	31 019 2 x		31 916 1 x		35 033 1 x		36 337 1 x
	31 021 1 x		31 981 4 x		35 049 6 x		36 443 1 x
	31 031 1 x		31 982 32 x		35 051 6 x		36 920 6 x
	31 036 1 x		31 983 3 x		35 063 3 x		36 921 2 x
	31 058 5 x		32 064 6 x		35 064 1 x		36 922 4 x
	31 124 2 x		32 071 4 x		35 065 3 x		36 950 2 x
	31 336 11 x		32 228 2 x		35 069 1 x		36 973 1 x
	31 337 9 x		32 229 1 x		35 088 2 x		37 031 1 x
	31 426 1 x		32 230 1 x		35 405 3 x		37 237 10 x
	31 436 3 x		32 850 3 x		35 969 2 x		37 468 12 x
	31 597 8 x		32 870 1 x		35 980 2 x		37 679 8 x
	31 667 4 x		32 879 2 x		36 227 6 x		37 681 1 x
	31 671 2 x		32 881 4 x		36 264 1 x		37 783 1 x
	31 674 3 x		32 913 2 x		36 293 4 x		37 858 1 x

Einzelteilübersicht
Spare parts list
Liste des pièces détachées

Onderdelenoverzicht
Lista da piezas
Resumo de peça individual

	38 216 4 x		68 451 1 x		143 235 4 x		146 534 1 x
	38 240 6 x		69 205 1 x		143 236 14 x		146 535 2 x
	38 241 2 x		116 913 2 x		146 142 2 x		35 608 1 x
	38 245 3 x		136 775 1 x		146 529 4 x		147 009 1 x
	38 413 3 x		137 103 1 x		146 531 4 x		
	38 423 6 x		137 357 1 x		146 532 4 x		
	38 428 6 x				146 533 12 x		

Montagetipps
Tips for assembly
Tuyaux pour le montage

Montagetips
Consejos para el montaje
"Dicas" para montagem

Consigli per il montaggio
Советы по сборке
装配建议

Kabel und Stecker
Plugs and cables
Fiches et des câbles

Stekkers en cables
Enchufes en cables
Cabos e contatos

Cavi e connettori
Провода и штекеры
电缆和插头

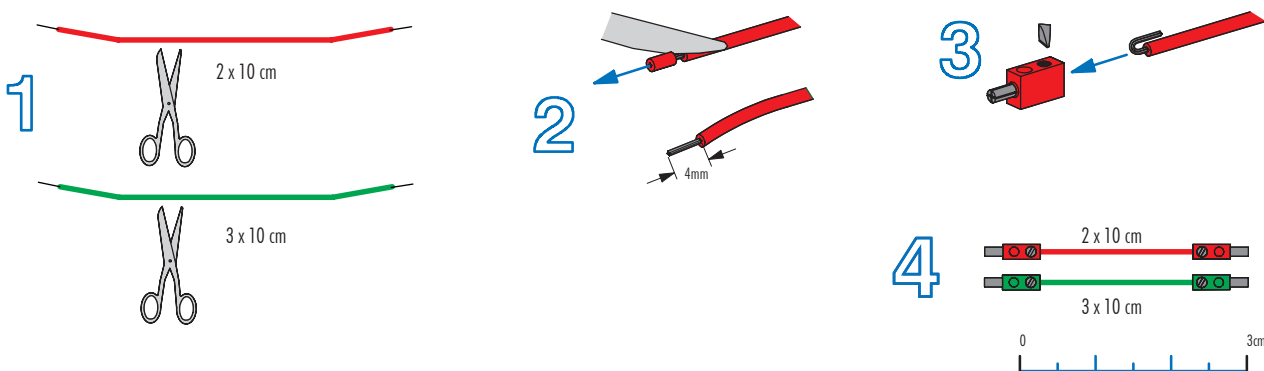
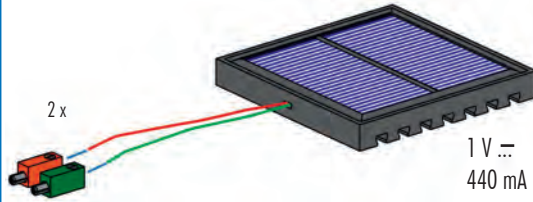

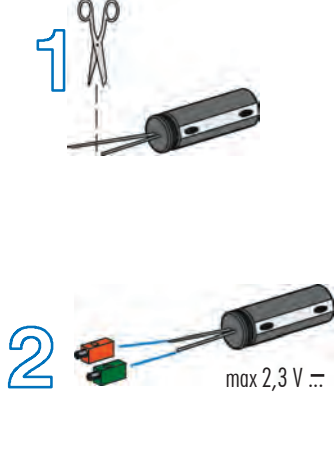

2 x
1 V ...
440 mA

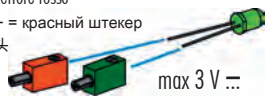

1
2
max 2,3 V ...

Langer Draht + = roter Stecker
Long wire + = red plug
Fil long + = fiche rouge
Lange draad + = rode stekker
Alambre largo + = conector rojo
Fio longo + = conector vermelho
Filo lungo + = connettore rosso
Длинный провод + = красный штекер
长电线 + = 红色插头



max 3 V ...

Kurzer Draht - = grüner Stecker
Short wire - = green plug
Fil court - = fiche verte
Korte draad - = groene stekker
Alambre corto - = conector verde
Fio curto - = conector verde
Filo corto - = connettore verde
Короткий провод - = зеленый штекер
短电线 - = 绿色插头